

zero downtime backup for the virtual array

executive summary

Zero Downtime Backup is an approach to data protection that utilizes physical or logical point-in-time copies (split-mirrors or snapshots) of production data to isolate production data access from the impact of data protection. Using Zero Downtime Backup, I.T. organizations supporting mission-critical applications can eliminate the backup window and any performance impact of data protection to deliver true high-performance 24x365 operations.

This paper presents an HP Zero Downtime Backup (ZDB) technical blueprint for building a staged backup storage solution for HP's mid-range Virtual Array (VA) environment, and includes the solution design rules, sample bills of material, and presents example ZDB solutions from a logical and physical view. Specifications are supplied for the solution components and a discussion of scaling the ZDB solutions is also provided. The example ZDB solution is for a SAN-attached configuration and assumes a fully loaded HP Surestore Virtual Array 7100 with 1.1 raw terabytes and HP Surestore Tape Library 4/40 with Ultrium LTO 230 drives.

Using the ZDB solutions described in this blueprint, customers can significantly reduce the time required to backup their data without affecting business application performance and availability. Customers may also obtain greater cost efficiencies by conducting backups to tape from multiple secondary copies so that tape devices do not sit idle for extended periods of time.

Figure 1 presents a logical view of a ZDB solution configured in a highly available SAN

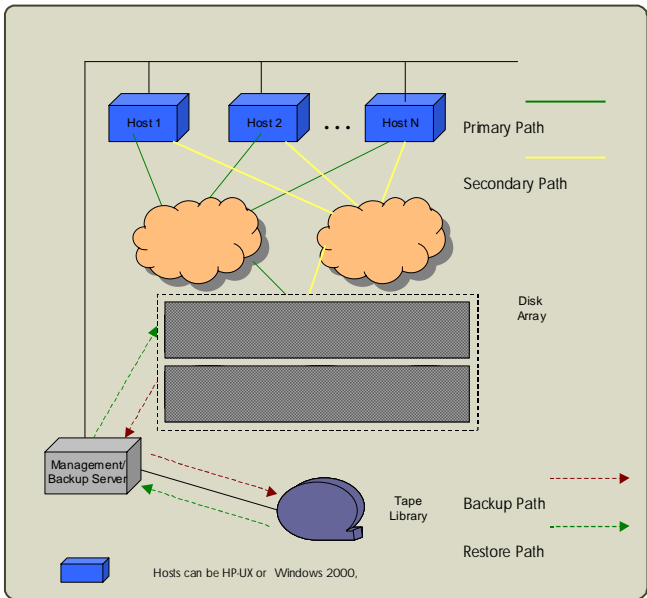

figure 1. zero downtime backup solution logical view

today's challenges in storage

Businesses today know that even planned downtime costs money. The process of backing up data in the traditional manner - directly to tape devices - can take hours to complete and slow application response significantly. This can directly affect revenue and productivity. The ZDB solution enables the customer to back up data in minutes rather than hours by first copying data to disk and then independently backing up that secondary copy to tape without affecting application I/O or data availability.

ZDB solutions also provide businesses with greater peace of mind that their data is safe. For example, if a business is relying on a traditional tape backup and the tape backup fails, there may not be time to perform a second backup in the remaining backup window. The customer is then exposed to the risk of an unplanned downtime event occurring without a backup copy in place. In this case, the ZDB solution provides the option of maintaining the disk copy as an insurance policy against failed tape backup. If an unplanned downtime event occurs after a tape backup failed, the customer can restore from the point in time disk copy with minimal impact to operations.

As data continues to grow in volume, businesses may face the possibility of having their revenue and productivity limited by their IT infrastructure's ability to keep up. ZDB solutions enable IT staff to be free of constraining traditional tape-only infrastructure by implementing a staged backup - first, copy to disk and *then* backup to tape - configuration. This enables IT staff to focus on efficiently managing and growing IT capabilities to meet business requirements rather than on constraining business operations to stay within the limits of the IT infrastructure.

The Zero Downtime Backup solution provides the following specific benefits:

- Enables customers to backup data in minutes rather hours, significantly reducing planned downtime, and keeping critical applications like SAP, Oracle and Exchange continuously accessible.
- Protects the customer against failed tape backups and the subsequent possibility of not being able to recover from an unplanned downtime event
- Provides customers the flexibility to manage and grow their environment without being constrained by a limited backup window
- Enables more efficient utilization of shared tape devices to help maximize IT ROI

why an hp zero downtime backup solution?

HP provides a fully tested and qualified, end-to-end solution built from industry-leading solution components that are easy-to-learn, easy-to-use, and supported by one point of contact - HP. With a commitment to quality, and a service and support organization of over 30,000 professionals in 120 countries around the world, HP provides customers the peace of mind that comes from knowing their solution works right today - and will keep working for them into the future.

The engine behind the Zero Downtime Backup for the Virtual Array solution, HP Business Copy VA, is powered by data replication technology with significant advantages over other technologies:





- Providing more than 100 snapshots with a va7100 and more than 1,000 snapshots with a va7400
- Supporting clustered host environments
- Enabling the administrator to take multiple snapshots of the parent volume
- Easy to use, easy to learn GUI interface and management console

HP's Omniback II - a core part of HP's OpenView storage area management software family - is fully integrated with Zero Downtime Backup. Omniback is based on a modular design, so it is scalable with a customer's infrastructure to provide highly reliable and cost-effective backup in systems of any size.

HP is also a leading provider of tape libraries shipping with LTO tape drives and offers some of the fastest read/write speeds of any tape device on the market. The HP tape library family enables customers to start as small as one drive (backing up more than 300 GB's in a standard 6 hour backup window w/ Ultrium LTO drives) and 20 slots or as big as 20 drives (backing up more than 6 terabytes in a standard 6 hour backup window w/ Ultrium LTO drives) and 700 slots.

HP has developed a strategy based on the concept of Federated Storage Area Management (FSAM), which delivers a naturally scalable environment of pooled storage resources working together as a seamless system. In federated computing, networked resources can be brought together to perform tasks and solve problems, and then can be reassigned to other tasks as business requirements change. With the HP Zero Downtime Backup solution, HP has made key alignments with the FSAM strategy.

key components

<p>HP Surestore Virtual Array family</p>		<ul style="list-style-type: none"> ▪ Pro-active self-monitoring and end-to-end checksums keep data intact across the entire data path ▪ Fault tolerant, redundant architecture w/ no single point of failure ▪ Multi-terabyte scalability
<p>HP Surestore Business Copy VA software</p>		<ul style="list-style-type: none"> ▪ More than 100 snapshots w/ va7100 & more than 1000 snapshots w/ va7400 ▪ Multiple snapshots per parent volume ▪ Cluster support and easy-to-learn, easy-to-use GUI
<p>HP OpenView Omniback II software</p>		<ul style="list-style-type: none"> ▪ Single, central management interface to monitor remote and local backup jobs and resources ▪ Tightly integrated w/ OpenView Management tools ▪ Highly scalable architecture and licensing
<p>HP Surestore Ultrium Tape Drives</p>		<ul style="list-style-type: none"> ▪ HP is leading developer of Ultrium LTO tape technology ▪ 54 GB/hour transfer rate* ▪ 100 GB per tape cartridge capacity* <p>*data compression can double transfer rates and capacities</p>
<p>HP Surestore Tape Libraries</p>		<ul style="list-style-type: none"> ▪ HP is a leading vendor of modular tape libraries ▪ Can seamlessly scale from 1 to 10 drives and 20 to 100 slots as the customer requires ▪ Up to 20 drives and 700 slots are also available w/ superior library management

hp zero downtime backup for the virtual array

The central element of a ZDB solution is the data replication engine that enables secondary copies to be made – and managed – from primary data volumes. In addition, the data replication management function is tightly integrated with a backup application – Omniback II - to enable the customer to easily manage the multiple data copies and the data replication process itself.

Given that the ZDB customer is highly concerned about their shrinking backup window, HP recommends Ultrium LTO tape drives – some of the fastest tape drive technology on the market – coupled with a scalable family of tape libraries to round out the ZDB solution offering. Although most of the critical operations of a ZDB solution occur at the logical perspective – copies of logical volumes being made, backed-up and restored – also included in this blueprint is a physical view of a ZDB solution in a SAN configuration

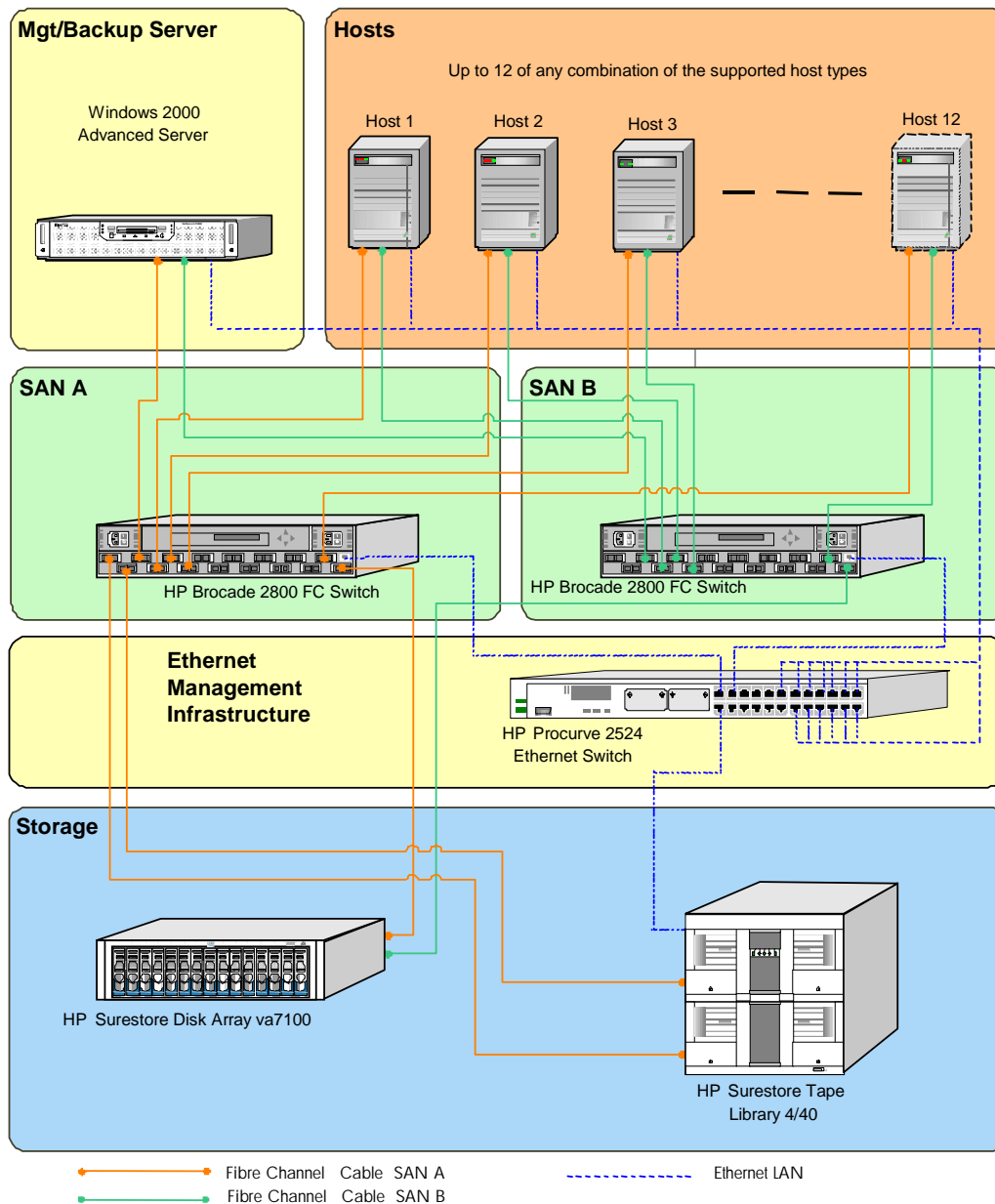

figure 2. zero downtime backup physical view

The Ethernet switch provides important LAN connectivity for out-of-band SAN component management. For example, host-based agent software can be loaded from the management server using the Ethernet connection. See the Bill of Materials for specific component information.

Also, the ZDB Solution in a highly available SAN configuration can be racked to minimize space at a customer's site.

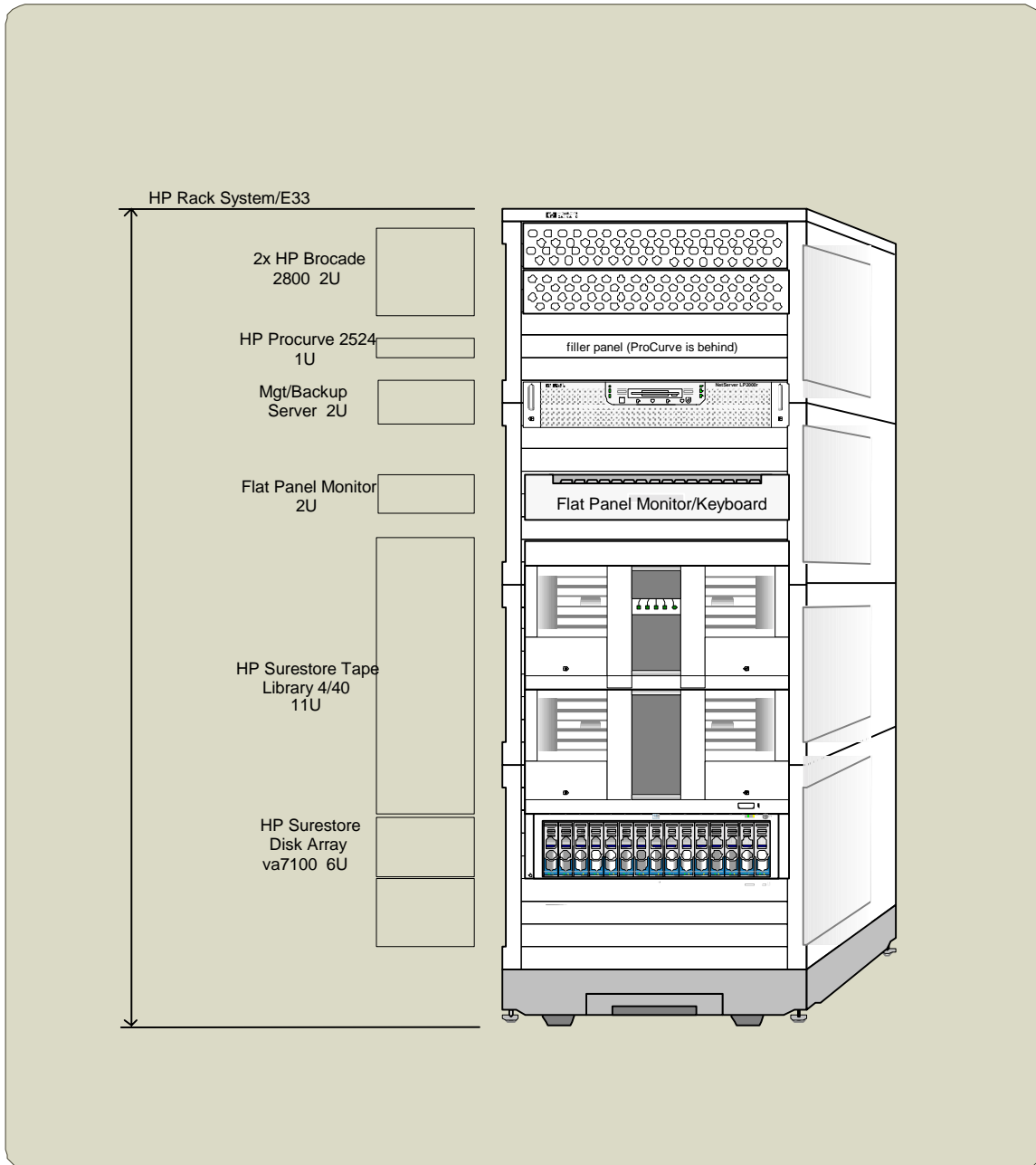

figure 3. example racked solution

If additional rack space is needed, for example, for FC switches or tape libraries, an HP Rack System/E41 may be used in place of the E33.

hp zero downtime backup for the virtual array: growing the solution

The example solution illustrated in this blueprint can be modified to meet specific customer needs. To provide this flexibility, the assumptions and design rules are listed below and ZDB solutions can be revised as necessary to meet customer requirements.

assumptions:

array

- va7100 is fully loaded (i.e., 15 drives)

tape

- Ultrium LTO 230 drives
- Incremental backups occur 6 days a week
- Full backups occur on the 7th day. Full backups take no more than 6 hours
- Access to library is not HA. There is a single physical path to the library
- ~Four full copies of data maintained within library (40 cartridges)

design rules:

- Backup Speed Rule of thumb: one Ultrium LTO drive can backup about 300 GB's of usable capacity in a 6-hour period (~50 GB's per hour)
 - If using 18GB drives in the va7100, HP recommends a 1/20 Ultrium tape library
 - Required # of Ultrium cartridges: 10
 - If using 36 GB drives in the va7100, HP recommends a 2/20 Ultrium tape library
 - Required # of Ultrium cartridges: 20
 - If using 73 GB drives in the va7100, HP recommends a 4/40 Ultrium tape:
 - Required # of Ultrium cartridges: 40
- SAN solutions may accommodate up to 12 hosts of any of the supported types w/ 2 switches in an HA fabric (see SAN supplement – "Supported Hosts" section)
- A total of 3 Fibre Channel switch ports are used for the management server and the va7100.
- Every two tape drives require one Fibre Channel port and one Fibre Channel bridge.

scaling options for the zero downtime backup solution

The Zero Downtime Backup for the Virtual Array example solution provided in this technical blueprint can also scale over time to meet expanding customer requirements. By adding an additional or larger HP Brocade Fibre Channel switch (e.g HP 6164 FC Switch), the example configuration may support additional hosts, storage arrays and tape libraries. For specific guidelines on selecting the appropriate components, please consult your HP sales representative or channel partner.

zero downtime backup for the virtual array solution specifications

To ensure that the latest supported software, firmware and driver revisions are being used for ZDB in SAN configurations, please check with you HP sales representative or channel partner.

supported hosts

Supported Hosts and HBA's

	HP-UX	Windows
OS Version	11.0 & 11.11	2000
HBA	A5158a (PCI); A6684A (HSC R class); A6685A (HSC K class)	QLogic 2200 F
Data Type		
Raw Disk	yes	yes
File System	yes	yes
Oracle	yes	future
Oracle Parallel Server	yes	future
SAP	yes	future
Exchange	n/a	yes
SQL Server	n/a	yes

interconnect

SAN Fibre Channel Infrastructure

Features	HP Brocade 2800	HP 6164 FC Switch
Number of Ports	16	64
Per Port Line Speed	1.0625 Gbps, Full Duplex	1.0625 Gbps, Full Duplex

storage

Disk Storage

Features	VA7100	VA7400
Array Raw Capacity	72 GB to 1.1 TB's	72 Gb to 7.7 TB's
External I/O Ports	Two 100 mbs	Two 200 mbs
Sustained Performance	90 mbps	170 mbs

Tape Storage

HP Surestore Tape Libraries*							
Features	1/20	2/20	4/40	6/60	10/100	10/180	20/700
Maximum Native* Transfer Rate per hour	54 GB	108 GB	216 GB	324 GB	540 GB	540 GB	1.1 TB
Max. Native* Capacity Backed Up in less than 6 hours	324 GB	648 GB	1.3 TB	1.9 TB	3.2 TB	3.2 TB	6.4 TB
Max. Native* Capacity Stored	2 TB	2 TB	4 TB	6 TB's	10 TB	18 TB	70 TB

(*Capacity can be expanded at a 2:1 ratio thru data compression)

management

Management/Backup Server

Features	Comments
HP NetServer LP2000r in the following configuration: <ul style="list-style-type: none"> • 2 Processors (1.3 GHZ or better) • 1.5 GB or more of 133MHz ECC SDRAM Redundant power supplies	Order Windows 2000 Advance Server
HP NetRAID 2M 64 MB Controller	
HP 18.2 GB 15K Ultra3 Wide SCSI-3 HS HD	Order a minimum of 4, a maximum of 6

Out-of-Band SAN Management – Ethernet Switch

Features	HP Procurve Switch 2512	HP Procurve Switch 2524
Number of Ports	12	24
Speed	10/100 mbs	10/100 mbs

Management/Backup Software Components

Application	Host Agent	Description
HP OpenView Storage Area Manager	yes	Enables device monitoring, capacity planning, Fibre Channel performance evaluation, billing and LUN management
HP OpenView Omniback II	yes	Manages backup and restore operations
HP Surestore Business Copy VA	no	Data replication
HP Surestore CommandView VA	no	Device management
HP Surestore Secure Manager VA	no	Provides device-based security to LUN's

services

Life cycle

	Description
Invent	Zero Downtime Backup Design
Build	Business Copy implementation
	Omniback implementation
	SAN implementation
Run	Business Continuity support
	SAN Environment support
Evolve	Performance/Capacity planning
	High Availability Storage Assessment

bill of materials

The following is a listed bill of materials representing the hardware and software used in the example SAN solution configuration in this blueprint.

Bill of Materials

Management/Backup Server		
QTY	DESCRIPTION	COMMENTS
1	HP NetServer LP2000r in the following configuration: 2 Processors (1.3MHz or better) 1.5 GB or more of 133MHz ECC SDRAM Redundant power supplies	Order Windows 2000 Advance Server
1	HP NetRAID 2M 64 MB Controller	
4	HP 18.2 GB 15K Ultra3 Wide SCSI-3 HS HD	Order a minimum of 4, a maximum of 6
2	QLogic 2200 Fibre Channel HBA	Must be ordered from another vendor or re-seller.
1	HP Procurve 2524 Switch	
OpenView Software		
QTY	DESCRIPTION	COMMENTS
Variable	HP OpenView Storage Area Manager	SAM Suite includes Storage Node Manager, Builder, Accountant, Optimizer and Allocator
1	HP OpenView Omniback II Cell Mgr Windows LTU	
Variable (* depends TB of used disk space)	HP OpenView Omniback II Snapshot Backup Extension for HP Surestore VA disk arrays	
Variable (* depends on host OS and # of drives)	HP OpenView Omniback II Drive Extension or UNIX, NAS, SAN	
Variable (* depends on host OS and # of drives)	HP OpenView Omniback II Drive Extension for NT / 2000 / VA, NetWare, Linux (Intel)	
Surestore Software		
QTY	DESCRIPTION	COMMENTS
1	HP Surestore Business Copy for the va7100 Media	
1	HP Surestore Business Copy VA 1 TB LTU	
1	HP Surestore Secure Manager VA media for va7100	
1	HP Surestore Secure Manager VA 1 TB LTU	
Virtual Array		
QTY	DESCRIPTION	COMMENTS
1	HP Surestore Disk Array va7100	Due to the multiple configuration options for the VA7xxx array, please contact an HP sales representative for ordering information.
HP Tape Libraries		
QTY	DESCRIPTION	COMMENTS
1	HP Surestore Tape Library 4/40	Base Ultrium library without drives
4	HP Surestore Ultrium 230 Tape Drive LVDS	Drives for the library
2	FC Bridge 1 FC Port, 2 LVDS SCSI ports	
40	HP Surestore Ultrium Data Cartridges, 100 GB (native)	
Interconnect		
QTY	DESCRIPTION	COMMENTS
Variable	Optical GBIC's	
2	HP Brocade 2800 FC Switch	
Host Hardware Components		
QTY	DESCRIPTION	COMMENTS
Variable	One port PCI 2x Fibre Channel Adapter	Two per HP-UX N, L or V class hosts
Variable	HSC Tachlite Fibre Channel Adapter	Two per HP-UX D or R class hosts
Variable	HSC Tachlite Fibre Channel Adapter	Two per HP-UX K class hosts
Variable	JNI FCE 6410 Fibre Channel HBA	Two per Sun Solaris 7 or 8 host. Must order from vendor or re-seller
Variable	JNI FCE-6460 Fibre Channel HBA	Two per Solaris 8 host. Must order from vendor or re-seller
Variable	QLogic 2200F Fibre Channel HBA	Two per Windows NT or Windows 2000 server. Must be ordered from another vendor or re-seller.

additional information

business continuity solutions

Additional HP Business Continuity technical blueprints:

- Zero Downtime Backup for the Virtual Array
- Zero Downtime Backup for the XP Array
- Entry-level SAN Backup
- Enterprise SAN Backup
- NAS 8000 Backup

To get answers on further implementation questions, contact your HP sales representative who will be able to consult regularly updated technical resources and provide additional guidance.

hp storage product components

To get further information on individual storage product components, go to www.hp.com/go/storage

hp storage service components

HP offers a complete life-cycle of storage support and consulting, for more information, go to www.hp.com/hps/storage

hp storage integration

HP also offers storage integration services, which provide a quick and trouble-free installation of your solution. For more information, go to www.hp.com/hps/gds

All brand names are trademarks of their respective owners.

Technical information in this document is subject to change without notice.

© Copyright Hewlett-Packard Company 2002

04/02