

SATA RAID Cards

ARC-1110/1120/1130/1160/1170

(4/8/12/16/24-port PCI-X SATA RAID Controllers)

ARC-1130ML/1160ML/1160ML2

(12/16-port Multi-lane connector PCI-X SATA RAID Controllers)

ARC-1210/1220/1230/1260/1280/

(4/8/12/16/24-port PCI-Express SATA RAID Controllers)

ARC-1231ML/1261ML/1280ML

(12/16/24-port PCI-Express SATA RAID Controllers)

ARC-1201 (OEM Version)

(8-Port PCI-Express x1 SATA RAID Controller)

USER Manual

Version: 4.1

Issue Date: August, 2009

Microsoft WHQL Windows Hardware Compatibility Test

ARECA is committed to submitting products to the Microsoft Windows Hardware Quality Labs (WHQL), which is required for participation in the Windows Logo Program. Successful passage of the WHQL tests results in both the “Designed for Windows” logo for qualifying ARECA PCI-X and PCI-Express SATA RAID controllers and a listing on the Microsoft Hardware Compatibility List (HCL).

Copyright and Trademarks

The information of the products in this manual is subject to change without prior notice and does not represent a commitment on the part of the vendor, who assumes no liability or responsibility for any errors that may appear in this manual. All brands and trademarks are the properties of their respective owners. This manual contains materials protected under International Copyright Conventions. All rights reserved. No part of this manual may be reproduced in any form or by any means, electronic or mechanical, including photocopying, without the written permission of the manufacturer and the author. All inquiries should be addressed to Areca Technology Corporation.

FCC STATEMENT

This equipment has been tested and found to comply with the limits for a Class B digital device, pursuant to part 15 of the FCC Rules. These limits are designed to provide reasonable protection against interference in a residential installation. This equipment generates, uses, and can radiate radio frequency energy and, if not installed and used in accordance with the instructions, may cause harmful interference to radio communications. However, there is no guarantee that interference will not occur in a particular installation.

Contents

1. Introduction	10
1.1 Overview	10
1.2 Features	12
2. Hardware Installation	16
2.1 Before Your Begin Installation	16
2.2 Board Layout.....	17
2.3 Installation.....	23
2.3.1 Hot-plug Drive Replacement	41
2.3.2 Recognizing a Drive Failure.....	41
2.3.3 Replacing a Failed Drive	41
3. McBIOS RAID Manager	44
3.1 Starting the McBIOS RAID Manager	44
3.2 McBIOS RAID manager	45
3.3 Configuring Raid Sets and Volume Sets	46
3.4 Designating Drives as Hot Spares.....	46
3.5 Using Quick Volume/Raid Setup Configuration	47
3.6 Using RAID Set/Volume Set Function Method	48
3.7 Main Menu	50
3.7.1 Quick Volume/RAID Setup	51
3.7.2 Raid Set Function	55
3.7.2.1 Create Raid Set	55
3.7.2.2 Delete Raid Set	57
3.7.2.3 Expand Raid Set.....	57
• Migrating	58
3.7.2.4 Activate Incomplete Raid Set.....	59
3.7.2.5 Create Hot Spare.....	59
3.7.2.6 Delete Hot Spare	60
3.7.2.7 Raid Set Information	61
3.7.3 Volume Set Function	61
3.7.3.1 Create Volume Set.....	62
• Volume Name	64
• Raid Level	64
• Capacity	65
• Stripe Size	66
• SCSI Channel	66
• SCSI ID	67
• SCSI LUN.....	67

• Cache Mode	68
• Tag Queuing	68
3.7.3.2 Delete Volume Set	69
3.7.3.3 Modify Volume Set	70
3.7.3.4 Check Volume Set	72
3.7.3.5 Stop Volume Set Check	72
3.7.3.6 Display Volume Set Info.	72
3.7.4 Physical Drives	73
3.7.4.1 View Drive Information	73
3.7.4.2 Create Pass-Through Disk	74
3.7.4.3 Modify a Pass-Through Disk	75
3.7.4.4 Delete Pass-Through Disk	75
3.7.4.5 Identify Selected Drive	75
3.7.5 Raid System Function	76
3.7.5.1 Mute The Alert Beeper	77
3.7.5.2 Alert Beeper Setting	77
3.7.5.3 Change Password	78
3.7.5.4 JBOD/RAID Function	79
3.7.5.5 Background Task Priority	79
3.7.5.6 Maximum SATA Mode	80
3.7.5.7 HDD Read Ahead Cache	81
3.7.5.8 Volume Data Read Ahead	81
3.7.5.9 Empty HDD slot LED	82
3.7.5.10 HDD SMART Status Polling	83
3.7.5.11 Controller Fan Detection	83
3.7.5.12 LED Polarity Setting	84
3.7.5.13 Auto Activate Raid Set	85
3.7.5.14 Disk Write Cache Mode	85
3.7.5.15 Capacity Truncation	86
3.7.6 HDD Power Management	87
3.7.6.1 Stagger Power On	87
3.7.6.2 Time to Hdd Low Power Idle	88
3.7.6.3 Time To Low RPM Mode	89
3.7.6.4 Time To Spin Down Idle Hdd	89
3.7.7 Ethernet Configuration (Ethernet Port Support)	90
3.7.7.1 DHCP Function	90
3.7.7.2 Local IP address	91
3.7.7.3 Ethernet Address	92
3.7.8 View System Events	92
3.7.9 Clear Events Buffer	93
3.7.10 Hardware Monitor	93
3.7.11 System Information	94

4. Driver Installation	95
4.1 Creating the Driver Diskettes	95
4.2 Driver Installation for Windows	97
4.2.1 New Storage Device Drivers in Windows 2003/XP-64/Vista .	97
4.2.2 Install Windows 2000/XP/2003/Vista on a SATA RAID Vol-	
ume.....	97
4.2.2.1 Installation Procedures	97
4.2.2.2 Making Volume Sets Available to Windows System	99
4.2.3 Installing Controller into an Existing Windows 2000/	
XP/2003/Vista Installation	99
4.2.3.1 Making Volume Sets Available to Windows System ...	101
4.2.4 Uninstall controller from Windows 2000/XP/2003/Vista..	101
4.3 Driver Installation for Linux	102
4.4 Driver Installation for FreeBSD.....	103
4.5 Driver Installation for Solaris 10.....	103
4.6 Driver Installation for Mac X	103
4.6.1 Installation Procedures.....	103
4.6.2 Making Volume Sets Available to Mac OS X	105
4.7 Driver Installation for UnixWare 7.1.4	105
4.8 Driver Installation for NetWare 6.5	105
5. ArchHttp Proxy Server Installation.....	106
5.1 For Windows.....	107
5.2 For Linux	108
5.3 For FreeBSD.....	110
5.4 For Solaris 10 x86	110
5.5 For Mac OS 10.x	110
5.6 ArchHttp Configuration	111
6. Web Browser-based Configuration	114
6.1 Start-up McRAID Storage Manager	114
• Start-up McRAID Storage Manager from Windows Local Admin-	
istration	115
• Start-up McRAID Storage Manager from Linux/FreeBSD/So-	
laris/Mac Local Administration	116
• Start-up McRAID Storage Manager Through Ethernet port	
(Out-of-Band)	116
6.2 McRAID Storage Manager.....	117
6.3 Main Menu	118
6.4 Quick Function.....	118
6.5 RaidSet Functions	119
6.5.1 Create Raid Set	119

6.5.2 Delete Raid Set	120
6.5.3 Expand Raid Set.....	120
6.5.4 Activate Incomplete Raid Set	121
6.5.5 Create Hot Spare	122
6.5.6 Delete Hot Spare.....	123
6.5.7 Rescue Raid Set	123
6.5.8 Offline Raid Set.....	123
6.6 Volume Set Functions	124
6.6.1 Create Volume Set.....	124
• Volume Name	125
• Raid Level	125
• Capacity	125
• Greater Two TB Volume Support.....	125
• Initialization Mode.....	125
• Stripe Size	126
• Cache Mode	126
• Tag Queuing	126
6.6.2 Delete Volume Set.....	127
6.6.3 Modify Volume Set.....	127
6.6.3.1 Volume Growth	127
6.6.3.2 Volume Set Migration	128
6.6.4 Check Volume Set	129
6.6.5 Stop VolumeSet Check	129
6.7 Physical Drive	130
6.7.1 Create Pass Through Disk.....	130
6.7.2 Modify Pass Through Disk.....	130
6.7.3 Delete Pass Through Disk	131
6.7.4 Identify Selected Drive.....	131
6.8 System Controls	132
6.8.1 System Config	132
• System Beeper Setting	132
• Background Task Priority	132
• JBOD/RAID Configuration	133
• Maximun SATA Supported	133
• HDD Read Ahead Cache	133
• Volume Data Read Ahead	133
• Empty HDD Slot LED	133
• HDD SMART Status Polling.....	134
• Auto Activate Incomplete Raid	134
• Disk Write Cache Mode	134
• Disk Capacity Truncation Mode.....	134
6.8.2 HDD Power Management.....	135

6.8.2.1 Stagger Power On Control.....	136
6.8.2.2 Time to Hdd Low Power Idle.....	136
6.8.2.3 Time To Hdd Low RPM Mode.....	136
6.8.2.4 Time To Spin Down Idle HDD.....	136
6.8.3 Ethernet Configuration (Ethernet Port Support).....	137
6.8.4 Alert by Mail Configuration (Ethernet Port Support).....	138
6.8.5 SNMP Configuration (Ethernet Port Support).....	138
6.8.6 NTP Configuration (Ethernet Port Support).....	139
6.8.7 View Events/Mute Beeper.....	141
6.8.8 Generate Test Event.....	141
6.8.9 Clear Events Buffer.....	142
6.8.10 Modify Password.....	142
6.8.11 Update Firmware.....	143
6.9 Information.....	143
6.9.1 RaidSet Hierarchy.....	143
6.9.2 System Information.....	144
6.9.3 Hardware Monitor.....	145
Appendix A.....	146
Upgrading Flash ROM Update Process.....	146
Upgrading Firmware Through McRAID Storage Manager.....	146
Upgrading Firmware Through nflash DOS Utility.....	148
Upgrading Firmware Through CLI.....	149
Appendix B.....	150
Battery Backup Module (ARC6120-BAT-xxx).....	150
BBM Components.....	150
Status of BBM.....	150
Installation.....	150
Battery Backup Capacity.....	151
Operation.....	151
Changing the Battery Backup Module.....	151
BBM Specifications.....	152
Appendix C.....	153
SNMP Operation & Definition.....	153
Appendix D.....	160
Event Notification Configurations.....	160
A. Device Event.....	160
B. Volume Event.....	161
C. RAID Set Event.....	162
D. Hardware Monitor Event.....	162
Appendix E.....	164
RAID Concept.....	164

RAID Set	164
Volume Set	164
Ease of Use Features.....	165
• Foreground Availability/Background Initialization	165
• Online Array Roaming	165
• Online Capacity Expansion.....	165
• Online RAID Level and Stripe Size Migration	167
• Online Volume Expansion	168
High availability.....	168
• Global Hot Spares	168
• Hot-Swap Disk Drive Support	169
• Auto Declare Hot-Spare	169
• Auto Rebuilding	170
• Adjustable Rebuild Priority	170
High Reliability	171
• Hard Drive Failure Prediction	171
• Auto Reassign Sector.....	171
• Consistency Check	172
Data Protection	172
• Battery Backup	172
• Recovery ROM	173
Appendix F	173
Understanding RAID	173
• RAID 0	174
• RAID 1	174
• RAID 10(1E)	175
• RAID 3	175
• RAID 5	176
• RAID 6	177
Appendix G	180
Technical Support	180

INTRODUCTION

1. Introduction

This section presents a brief overview of the SATA RAID Series controller, ARC-1110/1120/1130/1130ML/1160/1160ML/1160ML2/1170 (4/8/12/16/24-port PCI-X SATA RAID Controllers), ARC-1201(OEM version 8-port PCIex1 controller) and ARC-1210/1220/1230/1231ML/1260/1261ML/1280/1280ML (4/8/12/16/24-port PCIe SATA RAID Controllers).

1.1 Overview

The ARC-11xx and ARC-12xx series of high-performance Serial ATA RAID controllers support a maximum of 4, 8, 12, 16, or 24 SATA II peripheral devices (depending on model) on a single controller. The ARC-11xx series for the PCI-X bus and the ARC-12xx series for the PCI-Express bus. When properly configured, these SATA controllers provide non-stop service with a high degree of fault tolerance through the use of RAID technology and can also provide advanced array management features.

The 4 and 8 port SATA RAID controllers are low-profile PCI cards, ideal for 1U and 2U rack-mount systems. These controllers utilize the same RAID kernel that has been field-proven in Areca existing external RAID controllers, allowing Areca to quickly bring stable and reliable RAID controllers to the market.

Unparalleled Performance

The SATA RAID controllers provide reliable data protection for desktops, workstations, and servers. These cards set the standard with enhancements that include a high-performance Intel I/O Processor, a new memory architecture, and a high performance PCI bus interconnection. The 8/12/16/24-port controllers with the RAID 6 engine built-in can offer extreme-availability RAID 6 functionality. This engine can concurrently compute two parity blocks with performance very similar to RAID 5. The controllers by default support 256MB of ECC SDRAM memory for Intel IOP331/332/333. ARC-1201 RAID controller only supports 128MB DDR2-400 SDRAM. The 12/16/24 port controllers support one DDR333 SODIMM socket that allows for upgrading up to 1GB of memory. The 12/16/24

INTRODUCTION

port controllers support one DDR2-533 DIMM socket that allows for upgrading up to 2GB of memory. The controllers use Marvell 4/8 channel SATA PCI-X controller chips, which can simultaneously communicate with the I/O processor and read or write data on multiple drives.

Unsurpassed Data Availability

As storage capacity requirements continue to rapidly increase, users require greater levels of disk drive fault tolerance, which can be implemented without doubling the investment in disk drives. RAID 1 (mirroring) provides high fault tolerance. However, half of the drive capacity of the array is lost to mirroring, making it too costly for most users to implement on large volume sets due to doubling the number of drives required. Users want the protection of RAID 1 or better with an implementation cost comparable to RAID 5. RAID 6 can offer fault tolerance greater than RAID 1 or RAID 5 but only consumes the capacity of 2 disk drives for distributed parity data. The 8/12/16/24-port RAID controllers provide RAID 6 functionality to meet these demanding requirements.

The SATA RAID controllers also provide RAID levels 0, 1, 10(1E), 3, 5, 6, Single Disk or JBOD configurations. Its high data availability and protection is derived from the following capabilities: Online RAID Capacity Expansion, Array Roaming, Online RAID Level / Stripe Size Migration, Dynamic Volume Set Expansion, Global Online Spare, Automatic Drive Failure Detection, Automatic Failed Drive Rebuilding, Disk Hot-Swap, Online Background Rebuilding and Instant Availability/Background Initialization. During the controller firmware flash upgrade process, it is possible that an error results in corruption of the controller firmware. This could result in the device becoming non-functional. However, with our Redundant Flash image feature, the controller will revert back to the last known version of firmware and continue operating. This reduces the risk of system failure due to firmware crashes.

Easy RAID Management

The SATA RAID controller utilizes built-in firmware with an embedded terminal emulation that can access via hot key at M/B BIOS

INTRODUCTION

boot-up screen. This pre-boot manager utility can be used to simplify the setup and management of the RAID controller. The controller firmware also contains a web browser-based program that can be accessed through the ArchHttp proxy server function in Windows, Linux, FreeBSD and more environments. This web browser-based McRAID storage manager utility allows both local and remote creation and modification RAID sets, volume sets, and monitoring of RAID status from standard web browsers.

1.2 Features

Adapter Architecture

- Intel IOP 331 I/O processor (ARC-11xx series)
- Intel IOP 332/IOP 333 I/O processor (ARC-12xx series)
- Intel IOP341 I/O processor (ARC-12x1ML/ARC-1280ML/1280)
- ARM storage I/O processor (ARC-1201, OEM version)
- 64-bit/133MHz PCI-X Bus compatible
- PCI Express x8 compatible (IOP332/333)
- PCI Express x1 compatible (ARC-1201)
- 128MB DDR2-400 SDRAM (ARC-1201)
- 256MB on-board DDR333 SDRAM with ECC protection (4/8-port)
- One SODIMM Socket with default 256 MB of DDR333 SDRAM with ECC protection, upgrade to 1GB (12, 16 and 24-port cards only)
- One DIMM Socket with default 256 MB of DDR2-533 SDRAM with ECC protection, upgrade to 2GB(ARC-12xxML and ARC-1280)
- An ECC or non-ECC SDRAM module using x8 or x16 chip organization
- Support up to 4/8/12/16/24 SATA II drives
- Write-through or write-back cache support
- Multi-adapter support for large storage requirements
- BIOS boot support for greater fault tolerance
- BIOS PnP (plug and play) and BBS (BIOS boot specification) support
- Supports extreme performance Intel RAID 6 functionality
- NVRAM for RAID event & transaction log
- Battery backup module (BBM) ready (Depend on motherboard, ARC-1201 without BBM support)

INTRODUCTION

RAID Features

- RAID level 0, 1, 10(1E), 3, 5, 6, Single Disk and JBOD
- Multiple RAID selection
- Online array roaming
- Online RAID level/stripe size migration
- Online capacity expansion & RAID level migration simultaneously
- Online volume set growth
- Instant availability and background initialization
- Automatic drive insertion/removal detection and rebuilding
- Greater than 2TB per volume set for 64-bit LBA
- Redundant flash image for adapter availability
- Support SMART, NCQ and OOB staggered spin-up capable drives

Monitors/Notification

- System status indication through LED/LCD connector, HDD activity/fault connector, and alarm buzzer
- SMTP support for email notification
- SNMP agent supports for remote SNMP manager
- I2C Enclosure Management Ready (IOP331/332/333)
- I2C & SGPIO Enclosure Management Ready (IOP341/ARM)

RAID Management

- Field-upgradeable firmware in flash ROM
- Ethernet port support on 12/16/24-port and ARC-1201

In-Band Manager

- Hot key boot-up McBIOS RAID manager via M/B BIOS
- Support controller's API library, allowing customer to write its own AP
- Support Command Line Interface (CLI)
- Browser-based management utility via ArchHttp proxy server
- Single Admin Portal (SAP) monitor utility
- Disk Stress Test (DST) utility for production in Windows

Out-of-Band Manager

- Firmware-embedded browser-based MCRAID storage manager, SMTP manager, SNMP agent and Telnet function via Ethernet port (for 12/16/24-port adapter and ARC-1201)
- Support controller's API library for customer to write its own AP (for 12/16/24-port adapter and ARC-1201)
- Push Button and LCD display panel (option)

INTRODUCTION

Operating System

- Windows 2000/XP/Server 2003/Vista
- Red Hat Linux
- SuSE Linux
- FreeBSD
- Novell Netware 6.5
- Solaris 10 X86/X86_64
- SCO Unixware 7.1.4
- Mac OS 10.X (EFI BIOS support)

(For latest supported OS listing visit <http://www.areca.com.tw>)

Internal PCI-X RAID Card Comparison (ARC-11XX)					
	1110	1120	1130	1160	1170
RAID processor	IOP331				
Host Bus Type	PCI-X 133MHz				
RAID 6 support	Yes	Yes	Yes	Yes	Yes
Cache Memory	256MB	256MB	One SO-DIMM	One SO-DIMM	One SO-DIMM
Drive Support	4 x SATA II	8 x SATA II	12 x SATA II	16 x SATA II	24 x SATA II
Disk Connector	SATA	SATA	SATA	SATA	SATA

PCI-X RAID Card Comparison (ARC-11XML)		
	1130ML	1160ML/1160ML2
RAID processor	IOP331	
Host Bus Type	PCI-X 133MHz	
RAID 6 support	Yes	Yes
Cache Memory	One SODIMM	One SODIMM
Drive Support	12 x SATA II	16 x SATA II
Disk Connector	3 x Multi-lane	4 x Multi-lane/4 x SFF-8087

INTRODUCTION

Internal PCI-Express RAID Card Comparison (ARC-12XX)					
	1210	1220	1230	1260	1201
RAID processor	IOP332	IOP333			ARM
Host Bus Type	PCI-Express x8				PCI-Express x1
RAID 6 support	N/A	Yes	Yes	Yes	Yes
Cache Memory	256MB	256MB	One SODIMM	One SODIMM	128MB
Drive Support	4 * SATA II	8 * SATA II	12 x SATA II	16 x SATA II	8 x SATA II
Disk Connector	SATA	SATA	SATA	SATA	2 x SFF-8087

Internal PCI-Express RAID Card Comparison (ARC-12X1ML/1280)				
	1231ML	1261ML	1280ML	1280
RAID processor	IOP341			
Host Bus Type	PCI-Express x8			
RAID 6 support	Yes	Yes	Yes	Yes
Cache Memory	One DDR2 DIMM (Default 256MB, Upgrade to 2GB)			
Drive Support	12 x SATA II	16 x SATA II	24 x SATA II	24 x SATA II
Disk Connector	3 x SFF-8087	4 x SFF-8087	6 x SFF-8087	24 x SATA

HARDWARE INSTALLATION

2. Hardware Installation

This section describes the procedure for installing the SATA RAID controllers.

2.1 Before Your Begin Installation

Thank you for purchasing the SATA RAID Controller as your RAID data storage and management system. This user guide gives you a simple step-by-step instructions for installing and configuring the SATA RAID Controller. To ensure personal safety and to protect your equipment and data, please read the information carefully in pack content list before you begin installing.

Package Contents

If any items listed in your package is missing, please contact your local dealers before proceeding with installation **(disk drives and disk mounting brackets are not included)**:

ARC-11xx Series SATA RAID Controller

- 1 x PCI-X SATA RAID Controller in an ESD-protective bag
- 4/8/12/16/24 x SATA interface cables (one per port)
- 1 x Installation CD
- 1 x User Manual

ARC-1201 (OEM version) SATA RAID Controller

- 1 x PCI-Express x1 SATA RAID Controller in an ESD-protective bag
- 1 x Installation CD
- 1 x User Manual

ARC-12xx Series SATA RAID Controller

- 1 x PCI-Express SATA RAID Controller in an ESD-protective bag
- 4/8/12/16 x SATA interface cables (one per port)
- 1 x Installation CD
- 1 x User Manual

HARDWARE INSTALLATION

2.2 Board Layout

Follow the instructions below to install a PCI RAID Card into your PC / Server.

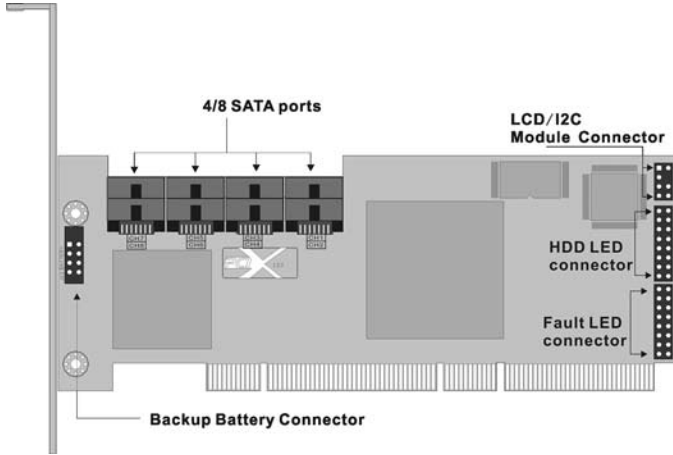

Figure 2-1, ARC-1110/1120 (4/8-port PCI-X SATA RAID Controller)

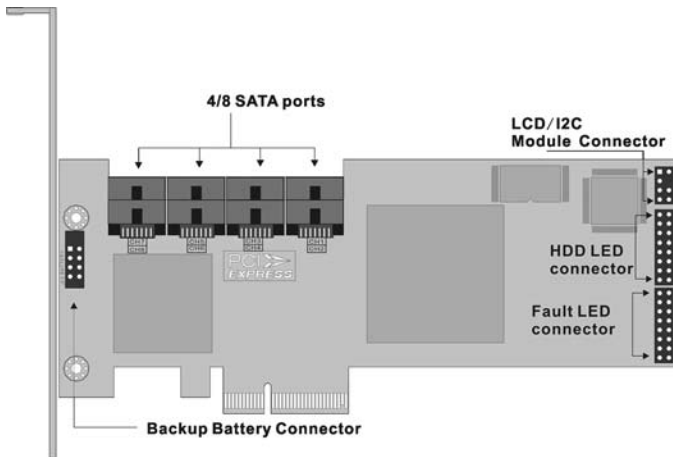

Figure 2-2, ARC-1210/1220 (4/8-port PCI-Express SATA RAID Controller)

HARDWARE INSTALLATION

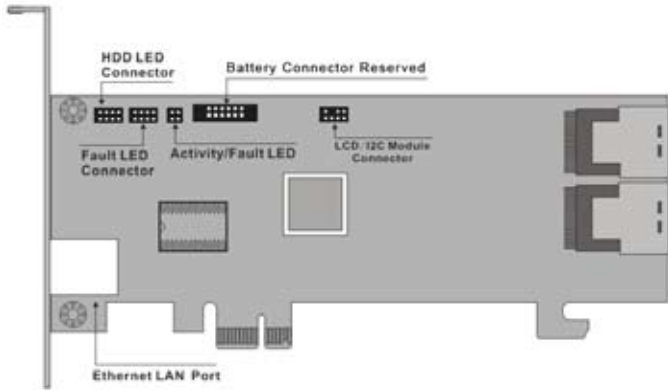

Figure 2-4, ARC-1201 (8-port PCI-Express SATA RAID Controller)

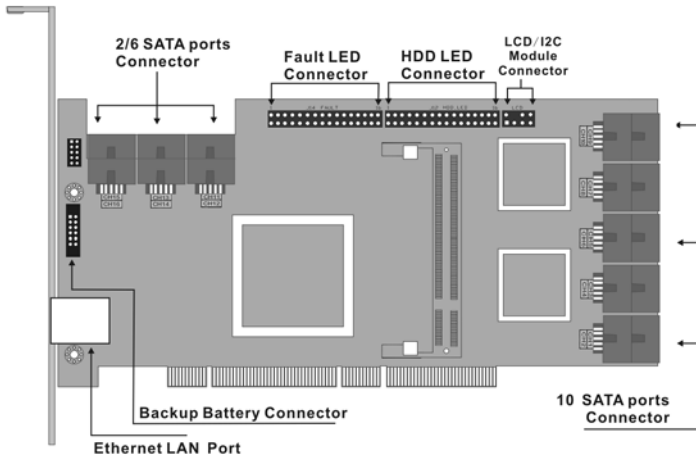

Figure 2-5, ARC-1130/1160 (12/16-port PCI-X SATA RAID Controller)

HARDWARE INSTALLATION

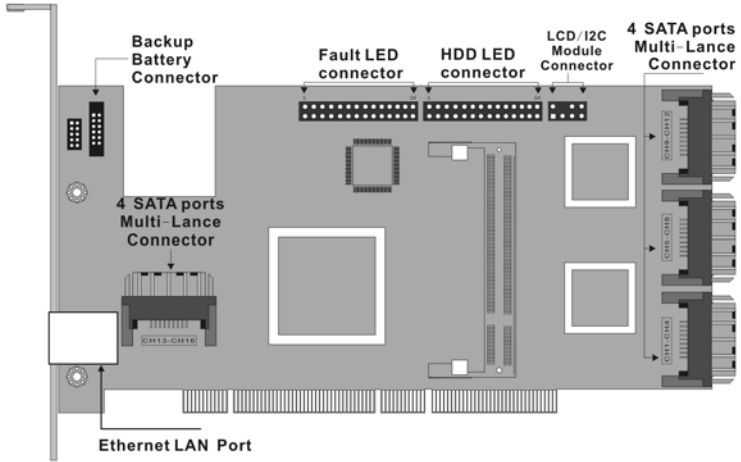

Figure 2-6, ARC-1130ML/1160ML (12/16-port PCI-X SATA RAID Controller)

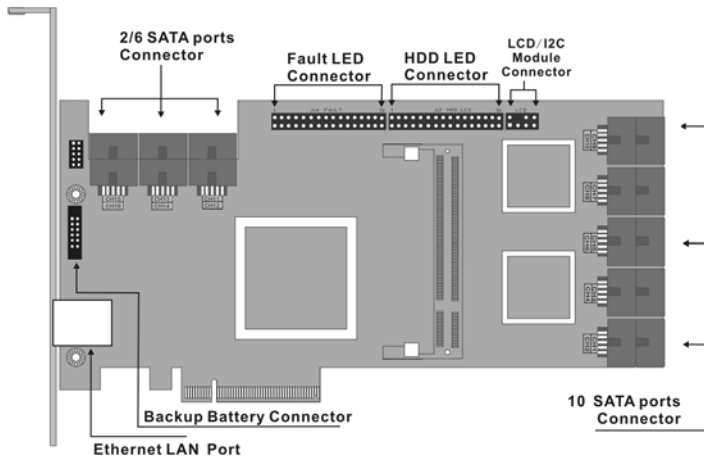

Figure 2-7, ARC-1230/1260 (12/16-port PCI-Express SATA RAID Controller)

HARDWARE INSTALLATION

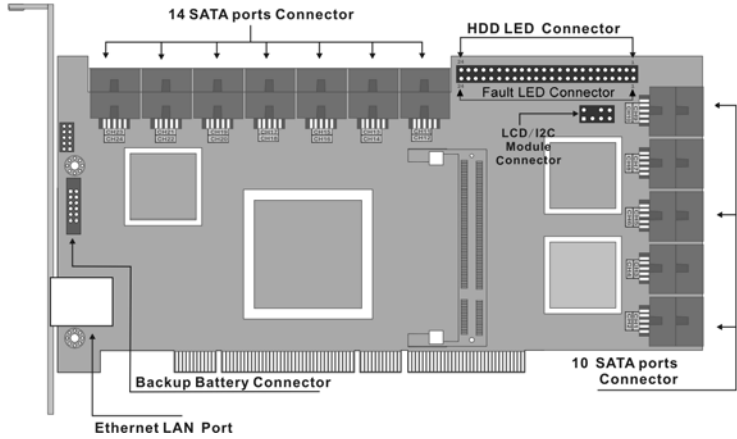

Figure 2-8, ARC-1170 (24-port PCI-X SATA RAID Controller)

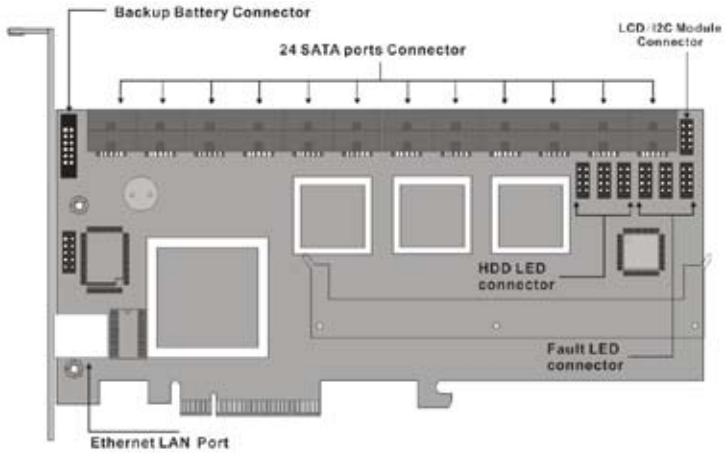

Figure 2-9, ARC-1280 (24-port PCI-Express SATA RAID Controller)

HARDWARE INSTALLATION

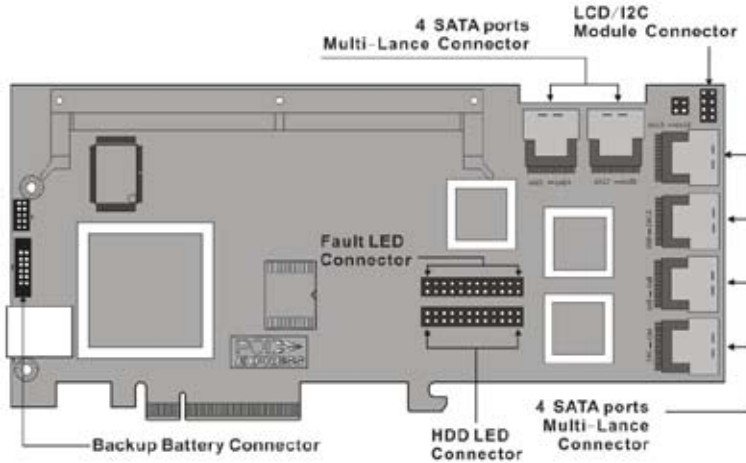

Figure 2-10, ARC-1231ML/1261ML/1280ML (12/16/24-port PCI-Express SATA RAID Controller)

Tools Required

An ESD grounding strap or mat is required. Also required are standard hand tools to open your system's case.

System Requirement

The controller can be installed in a universal PCI slot and requires a motherboard that:

ARC-11xx series required one of the following:

- Complies with the PCI Revision 2.3 32/64-bit 33/66MHz, 3.3V.
- Complies with the PCI-X 32/64-bit 66/100/133 MHz, 3.3V.

ARC-12xx series requires:

- Complies with the PCI-Express x8

It can also work on the PCIe x1, x4, x8 and x16 signal with x8 or x16 slot M/B.

ARC-1201 requires:

- Complies with the PCI-Express x1

It can also work on the PCIe x1, x4, x8 and x16 signal M/B.

The SATA RAID controller may be connected to up to 4 or 8 SATA II hard drives using the supplied cables.

Optional cables are required to connect any drive activity LEDs and fault LEDs on the enclosure to the SATA RAID controller.

HARDWARE INSTALLATION

Installation Tools

The following items may be needed to assist with installing the SATA RAID controller into an available PCI expansion slot.

- Small screwdriver
- Host system hardware manuals and manuals for the disk or enclosure being installed.

Personal Safety Information

To ensure personal safety as well as the safety of the equipment:

- Always wear a grounding strap or work on an ESD-protective mat.
- Before opening the system cabinet, turn off power switches and unplug the power cords. Do not reconnect the power cords until you have replaced the covers.

Warning:

High voltages may be found inside computer equipment. Before installing any of the hardware in this package or removing the protective covers of any computer equipment, turn off power switches and disconnect power cords. Do not reconnect the power cords until you have replaced the covers.

Electrostatic Discharge

Static electricity can cause serious damage to the electronic components on this SATA RAID controller. To avoid damage caused by electrostatic discharge, observe the following precautions:

- Do not remove the SATA RAID controller from its anti-static packaging until you are ready to install it into a computer case.
- Handle the SATA RAID Controller by its edges or by the metal mounting brackets at its each end.
- Before you handle the SATA RAID controller in any way, touch a grounded, anti-static surface, such as an unpainted portion of the system chassis, for a few seconds to discharge any built-up static electricity.

HARDWARE INSTALLATION

2.3 Installation

Follow the instructions below to install a SATA RAID controller into your PC / Server.

Step 1. Unpack

Unpack and remove the SATA RAID controller from the package. Inspect it carefully, if anything is missing or damaged, contact your local dealer.

Step 2. Power PC/Server Off

Turn off computer and remove the AC power cord. Remove the system's cover. See the computer system documentation for instruction.

Step 3. Install the PCI RAID Cards

To install the SATA RAID controller remove the mounting screw and existing bracket from the rear panel behind the selected PCI slot. Align the gold-fingered edge on the card with the selected PCI expansion slot. Press gently but firmly down to ensure that the card is properly seated in the slot, as shown in Figure 2-11. Next, screw the bracket into the computer chassis. ARC-11xx controllers can fit in both PCI (32-bit/3.3V) and PCI-X slots. It can get the best performance installed in a 64-bit/133MHz PCI-X slot. ARC-12xx controllers require a PCI-Express x8 slot.

HARDWARE INSTALLATION

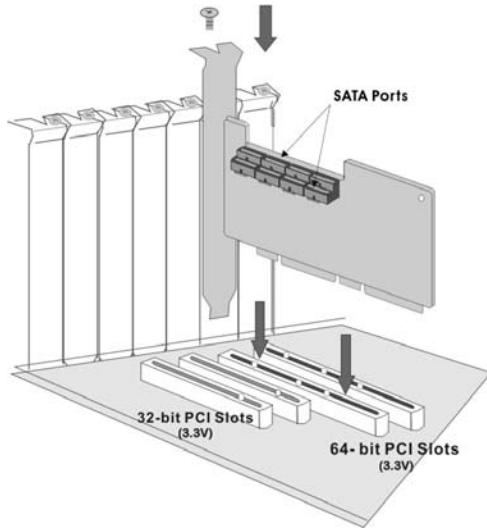

Figure 2-11, Insert SATA RAID controller into a PCI-X slot

Step 4. Mount the Cages or Drives

Remove the front bezel from the computer chassis and install the cages or SATA Drives in the computer chassis. Loading drives to the drive tray if cages are installed. Be sure that the power is connected to either the cage backplane or the individual drives.

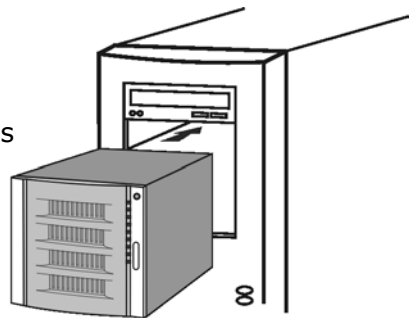

Figure 2-12, Mount Cages & Drives

HARDWARE INSTALLATION

Step 5. Connect the SATA Cable

Model ARC-11XX and ARC-12XX controllers have dual-layer SATA internal connectors. If you have not yet connected your SATA cables, use the cables included with your kit to connect the controller to the SATA hard drives.

The cable connectors are all identical, so it does not matter which end you connect to your controller, SATA hard drive, or cage backplane SATA connector.



Figure 2-13, SATA Cable

Note:

The SATA cable connectors must match your HDD cage. For example: Channel 1 of RAID Card connects to channel 1 of HDD cage, channel 2 of RAID Card connects to channel 2 of HDD cage, and follow this rule.

Step 5-2. Connect the Multi-lance Cable

Model ARC-11XXML has multi-lance internal connectors, each of them can support up to four SATA drives. These adapters can be installed in a server RAID enclosure with a Multi-lance connector (SFF-8470) backplane. Multi-lance cables are not included in the ARC-11XXML package.

If you have not yet connected your Multi-lance cables, use the cables included with your enclosure to connect your controller to the Multi-lance connector backplane. This type of cable will depend on what enclosure you have. The following diagram shows one example picture of Multi-lance cable.

Unpack and remove the PCI RAID cards. Inspect it carefully. If anything is missing or damaged, contact your local dealer.

HARDWARE INSTALLATION

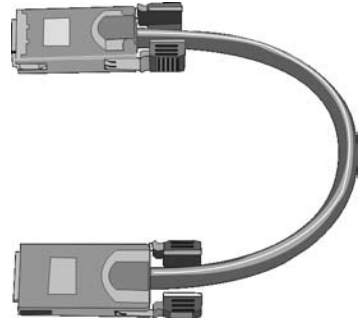

Figure 2-14, Multi-Lance Cable

Step 5-3. Connect the Min SAS 4i to 4*SATA Cable

Model ARC-1231ML/1261ML/1280ML have Min SAS 4i (SFF-8087) internal connectors, each of them can support up to four SATA drives. These adapters can be installed in a server RAID enclosure with a standard SATA connector backplane. Min SAS 4i to SATA cables are included in the ARC-1231ML/1261ML/1280ML package. The following diagram shows the picture of MinSAS 4i to 4*SATA cables.

Unpack and remove the PCI RAID cards. Inspect it carefully. If anything is missing or damaged, contact your local dealer.

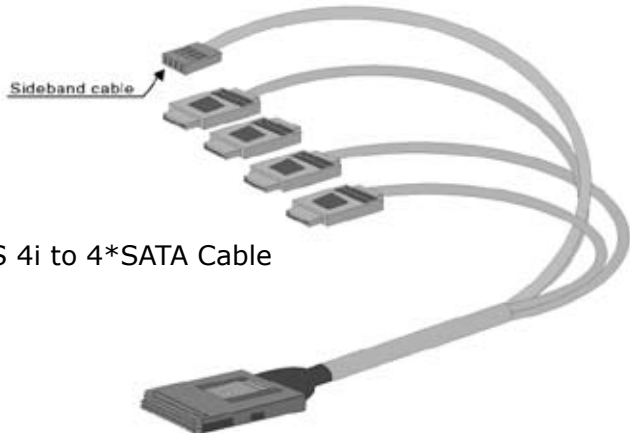

Figure 2-15, Min SAS 4i to 4*SATA Cable

For sideband cable signal Please refer to page 37 for SGPIO bus.

HARDWARE INSTALLATION

Step 5-4. Connect the Min SAS 4i to Multi-lance Cable

Model ARC-1231ML/1261ML/1280ML have Min SAS 4i internal connectors, each of them can support up to four SATA drives. These controllers can be installed in a server RAID enclosure with a Multi-lance connector (SFF-8470) backplane. Multi-lance cables are not included in the ARC-12XXML package.

If you have not yet connected your Min SAS 4i to Multi-lance cables, buy the Min SAS 4i to Multi-lance cables to fit your enclosure. And connect your controller to the Multi-lance connector backplane. The type of cable will depend on what enclosure you have. The following diagram shows one example picture of Min SAS 4i to Multi-lance cable.

Unpack and remove the PCI RAID cards. Inspect it carefully. If anything is missing or damaged, contact your local dealer.

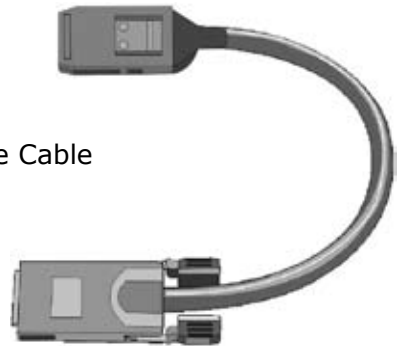

Figure 2-16, Min SAS 4i to Multi-lance Cable

Step 5-5. Connect the Min SAS 4i to Min SAS 4i Cable

Model ARC-1231ML/1261ML/1280ML have Min SAS 4i (SFF-8087) internal connectors, each of them can support up to four SATA drives and SGPIO (Serial General Purpose Input/Output) side-band signals . These adapters can be installed in a server RAID enclosure with a Min SAS 4i internal connector backplane. Min SAS 4i cables are not included in the ARC-12XXML package.

This Min SAS 4i cable has eight signal pins to support four SATA drives and six pins for the SGPIO (Serial General Purpose Input/Output) side-band signals. The SGPIO bus is used for efficient LED management and for sensing drive Locate status. Please see page 52 for the details of the SGPIO bus.

HARDWARE INSTALLATION

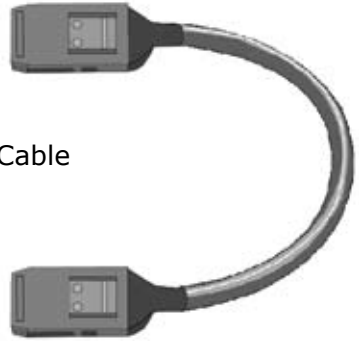

Figure 2-17, Min SAS 4i to Min SAS 4i Cable

The SGPIO signal can carry the fault/activity signal without needing any individual LED cable. The SGPIO is included in the SFF-8087.

- **Min SAS 4i Connector (SFF-8087) Signal**

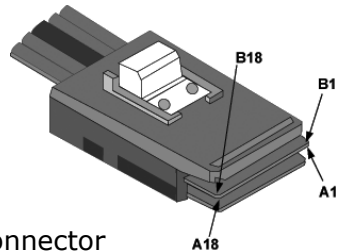

Figure 2-18, Min SAS 4i (SFF-8087) Connector

Name	Pin	Name	Pin
HDD R0+	A2	HDD T0+	B2
HDD R0-	A3	HDD T0-	B3
HDD R1+	A5	HDD T1+	B5
HDD R1-	A6	HDD T1-	B6
Sideband 0	A8	Sideband 7	B8
Sideband 1	A9	Sideband 3	B9
Sideband 2	A10	Sideband 4	B10
Sideband 6	A11	Sideband 5	B11
HDD R2+	A13	HDD T2+	B13
HDD R2-	A14	HDD T2-	B14

HARDWARE INSTALLATION

HDD R3+	A16	HDD T3+	B16
HDD R3-	A17	HDD T3-	B17
GND	A1, A4, A7, A12, A15, A18	GND	B1, B4, B7, B12, B15, B18

Table-1 Min SAS 4i cable(SFF8087) pin assignment

Step 5-6. Connect the Min SAS 4x to Min SAS 4x Cable

Model ARC-12X0ML/12X1ML have external Min SAS 4x (SFF-8088) connectors, each of them can support up to four SATA drives. These adapters can be installed in a server which works with external RAID enclosure with a Min SAS 4x connector. External Min SAS 4x cables are not included in the ARC-12X0ML/12X1ML package.

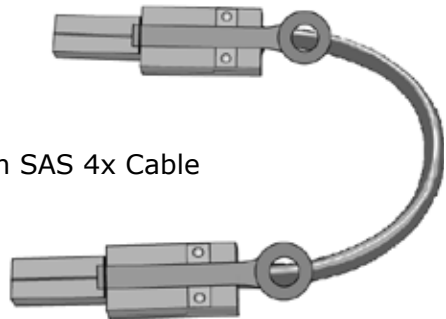

Figure 2-19, Min SAS 4x to Min SAS 4x Cable

If you have not connected your Min SAS 4x cables yet, use the cables included with your enclosure to connect your controller to the Min SAS 4x connector. This type of cable will depend on what enclosure you have. The above diagram shows one example picture of Min SAS 4x cable.

Step 6. Install the LED Cable (optional)

ARC-1XXX Series Fault/Activity Header Intelligent Electronics Schematic.

HARDWARE INSTALLATION

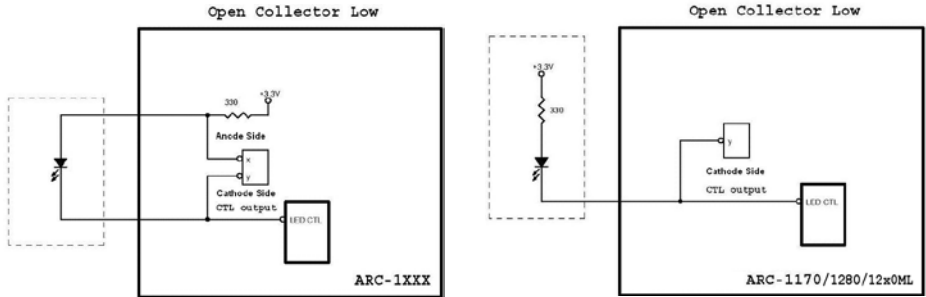

The intelligent LED controller outputs a low-level pulse to determine if status LEDs are attached to pin sets 1 and 2. This allows automatic controller configuration of the LED output. If the logical level is different between the first 2 sets of the HDD LED header (LED attached to Set 1 but not Set 2), the controller will assign the first HDD LED header as the global indicator connector. Otherwise, each LED output will show only individual drive status.

The SATA RAID controller provides four kinds of LED status connectors.

- A: Global indicator connector, which light up when any drive is active.
- B: Individual LED indicator connector, for each drive channel.
- C: I²C connector, for SATA proprietary backplane enclosure.
- D: SGPIO connector for SAS backplane enclosure

The following diagrams and description describes each type of connector.

Note:

A cable for the global indicator comes with your computer system. Cables for the individual drive LEDs may come with a drive cage or you may need to purchase them.

HARDWARE INSTALLATION

A: Global indicator connector

If the system use only a single global indicator, attach the global indicator cable to the two pins HDD LED connector. The following diagrams show the connector and pin locations.

Figure 2-20, ARC-1110/1120/1210/1220 global LED connection for computer case.

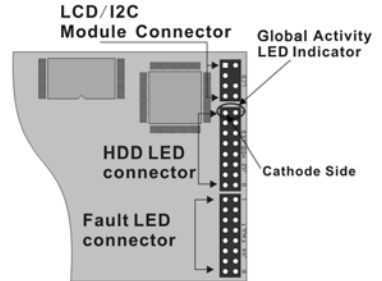

Figure 2-21, ARC-1130/1160/1230/1260 global LED connection for computer case.

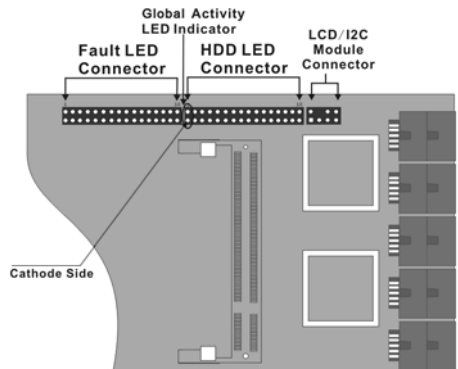
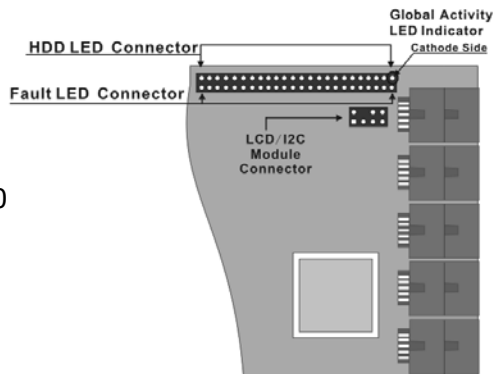

Figure 2-22, ARC-1170 global LED connection for computer case.



HARDWARE INSTALLATION

Figure 2-23, ARC-1280 global LED connection for computer case.

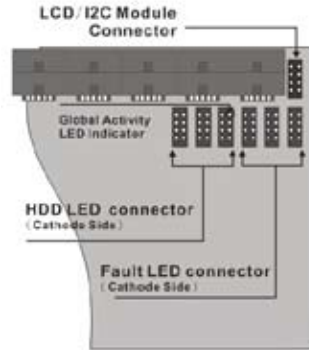

Figure 2-24, ARC-1231ML/1261ML/1280ML global LED connection for computer case.

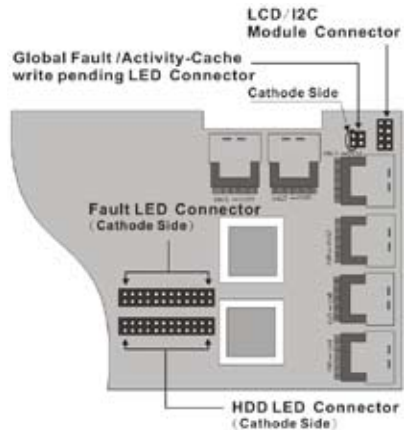
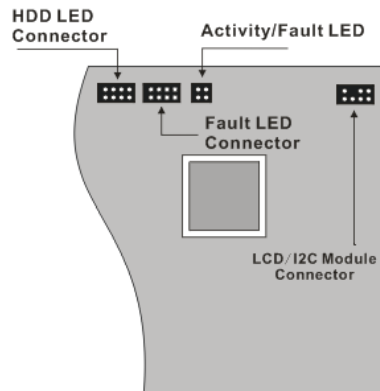

Figure 2-25, ARC-1201 LED connection for computer case.



HARDWARE INSTALLATION

B: Individual LED indicator connector

Connect the cables for the drive activity LEDs and fault LEDs between the backplane of the cage and the respective connector on the SATA RAID controller. The following describes the fault/activity LED.

LED	Normal Status	Problem Indication
Activity LED	When the activity LED is illuminated, there is I/O activity on that disk drive. When the LED is dark, there is no activity on that disk drive.	N/A
Fault LED	When the fault LED is solid illuminated, there is no disk present and When the fault LED is off, that disk is present and status is normal. When the "Identify Drive" is selected, the selected drive fault LED will blank.	When the fault LED is slow blinking (2 times/sec), that indicate disk drive has failed and should be hot-swapped immediately. When the activity LED is illuminated and fault LED is fast blinking (10 times/sec) that indicate there is rebuilding activity on the disk drive.

Figure 2-26, ARC-1110/1120/1210/1220 individual LED indicators connector, for each channel drive.

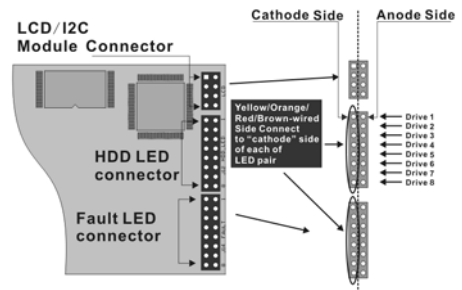

HARDWARE INSTALLATION

Figure 2-27, ARC-1130/1160/1230/1260 individual LED indicators connector, for each channel drive.

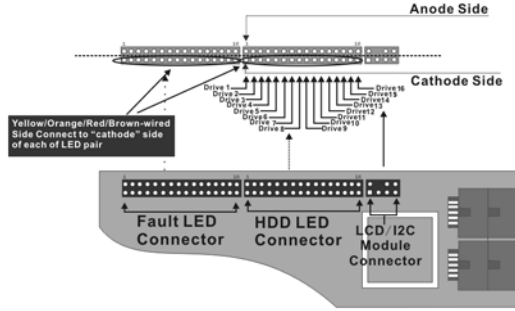

Figure 2-28, ARC-1170 individual LED indicators connector, for each channel drive.

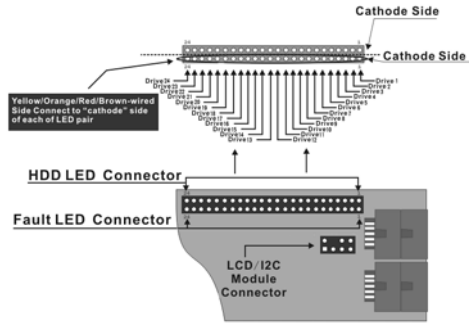
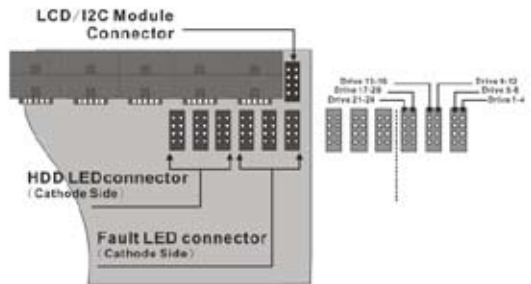

Figure 2-29, ARC-1280 individual LED indicators connector, for each channel drive.



HARDWARE INSTALLATION

Figure 2-30, ARC-1231ML/1261ML/1280ML individual LED indicators connector, for each channel drive.

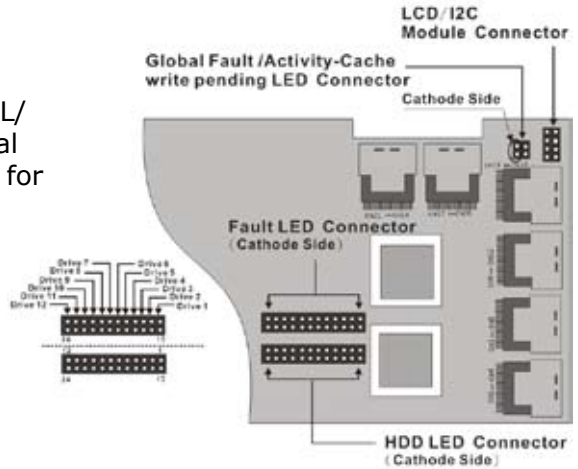
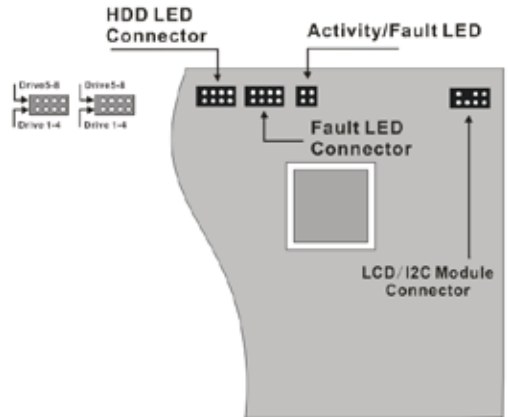

Figure 2-31, ARC-1201 individual LED indicators connector, for each channel drive.



C: I²C Connector

You can also connect the I²C interface to a SATA backplane enclosure which includes Areca CPLD decoder controller on the backplane. This can reduce the number of activity LED and/or fault LED cables. The I²C interface can also cascade to another SATA backplane enclosure for the additional channel status display.

HARDWARE INSTALLATION

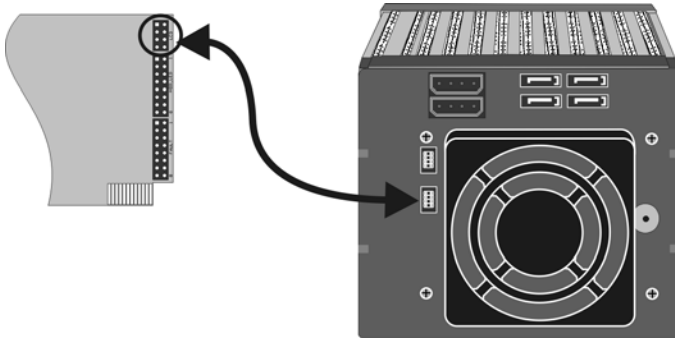

Figure 2-32, Activity/Fault LED I²C connector connected between SATA RAID controller & SATA HDD cage backplane.

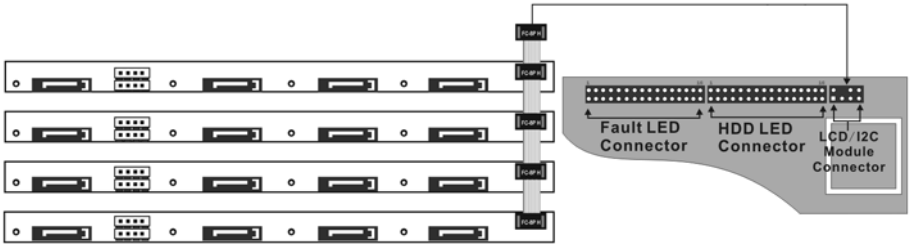
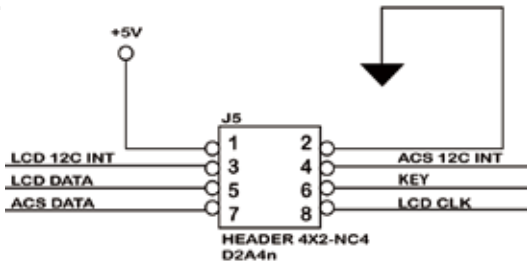

Figure 2-33, Activity/Fault LED I²C connector connected between SATA RAID controller & 4 SATA HDD backplane.

Note:

Ci-Design has supported this feature in its 4-port 12-6336-05A SATA II backplane.

The following is the I²C signal name description for LCD & fault/activity LED.



HARDWARE INSTALLATION

PIN	Description	PIN	Description
1	power (+5V)	2	GND
3	LCD Module Interrupt	4	Protective Key
5	LCD Module Serial Data	6	Fault/Activity clock
7	Fault/Activity Serial Data	8	LCD Module clock

D: SGPIO bus

The preferred I/O connector for server backplanes is the Min SAS 4i (SFF-8087) internal serial-attachment connector. This connector has eight signal pins to support four SATA drives and six pins for the SGPIO (Serial General Purpose Input/Output) sideband signals which use to replace the individual LED cable.

The SGPIO bus is used for efficient LED management and for sensing drive locate status. See SFF 8485 for the specification of the SGPIO bus. The number of drives supported can be increased, by a factor of four, by adding similar backplane to maximum of 24 drives (6 backplanes)

LED Management: The backplane may contain LEDs to indicate drive status. Light from the LEDs could be transmitted to the outside of the server by using light pipes mounted on the SATA drive tray. A small CPLD on the backplane, connected via the SGPIO bus to a ARC-1231ML/1261ML/1280ML SATA RAID controller, could control the LEDs. Activity: blinking/controller access Fault: solid illuminated

Drive Locate Circuitry: The locate of a drive may be detected by sensing the voltage level of one of the pre-charge pins before and after a drive is installed. Fault blinking 2 times/second.

The following signal defines the SGPIO assignments for the Min SAS 4i connector (SFF-8087) in ARC-1231ML/1261ML/1280ML.

HARDWARE INSTALLATION

PIN	Description	PIN	Description
SideBand0	SClock (Clock signal)	SideBand1	SLoad (Last clock of a bit stream)
SideBand2	Ground	SideBand3	Ground
SideBand4	SDataOut (Serial data output bit stream)	SideBand5	SDataIn (Serial data input bit stream)
SideBand6	Reserved	SideBand7	Reserved

The following signal defines the sideband connector which can work with Areca sideband cable on its SFF-8087 to 4 SATA cable. The sideband header is located at backplane. For SGPIO to work properly, please connect Areca 8-pin sideband cable to the sideband header as shown above. See the table for pin definitions.

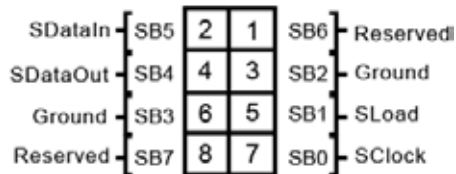

Sideband Pin Definitions

Step 7. Re-check the SATA HDD LED and Fault LED Cable Connections

Be sure that the proper failed drive channel information is displayed by the fault and HDD activity LEDs. An improper connection will tell the user to "Hot Swap" the wrong drive. This will remove the wrong disk (one that is functioning properly) from the controller. This can result in failure and loss of system data.

Step 8. Power up the System

Check the installation thoroughly, reinstall the computer cover, and reconnect the power cord cables. Turn on the power switch at the rear of the computer (if equipped) and then press the power button at the front of the host computer.

HARDWARE INSTALLATION

Step 10. Install the Controller Driver

For a new system:

- Driver installation usually takes places as part of operating system installation. Please refer to Chapter 4 Diver Installation for the detail installation procedure.

In an existing system:

- Install the controller driver into the existing operating system. Please refer to the Chapter 4, Driver Installation, for the detailed installation procedure.

Note:

For latest release versions of drivers, please download from <http://www.areca.com.tw>

Step 11. Install ArchHttp Proxy Server

The SATA RAID controller firmware has embedded the web-browser McRAID storage manager. ArchHttp proxy server will enable it. The browser-based McRAID storage manager provides all of the creation, management, and monitor SATA RAID controller status. Please refer to the Chapter 5 for the detail ArchHttp Proxy Server Installation. For SNMP agent function, please refer to Appendix C.

Step 12. Configure Volume Set

The SATA RAID controller configures RAID functionality through the McBIOS RAID manager. Please refer to Chapter 3, McBIOS RAID manager, for the detail regarding configuration. The RAID controller can also be configured through the McRAID storage manager software utility with ArchHttp proxy server installed through on-board LAN port or LCD module. For this option, please refer to Chapter 6, Web Browser-Based Configuration or LCD Configuration Menu.

HARDWARE INSTALLATION

Step 13. Determining the Boot Sequences

For PC system:

- The SATA RAID controller is a bootable controller. If your system already contains a bootable device with an installed operating system, you can set up your system to boot a second operating system from the new controller. To add a second bootable controller, you may need to enter setup of M/B BIOS and change the device boot sequence so that the SATA RAID controller heads the list. If the system BIOS setup does not allow this change, your system may not be configurable to allow the SATA RAID controller to act as a second boot device.

For Mac Pro system:

- The currently Mac OS X 10.4.7 or 10.5 Leopard can not directly boot up from Areca controller's volume (We do not support the Open Firmware) on the Power Mac G5 machine and can only use as a secondary storage. All Intel based Mac Pro machines use EFI to boot (not Open Firmware, which was used for PPC Macs) the system. Areca has supported the EFI BIOS on its PCIe SATA RAID adapter. You have other alternatively to add Areca volume set on the Mac Pro bootable device listing. You can follow the following procedures to add Areca PCIe SATA RAID controller on the Mac Pro bootable device listing.

- (1). Upgrade the EFI BIOS from shipping <CD-ROM>\Firmware\Mac\ directory or from the www.areca.com.tw, if the adapters default ship with a legacy BIOS for the PC. Please follow the Appendix A Upgrading Flash ROM Update Process to update the legacy BIOS to EFI BIOS for Mac Pro to boot up from Areca controller's volume.

- (2). Ghost (such as Carbon Copy Cloner ghost utility) the Mac OS X 10.4.X or 10.5 system disk on the Mac Pro to the Areca External PCIe SATA RAID controller volume set. Carbon Copy Cloner is an archival type of back up software. You can take your whole Mac OS X system and make a carbon copy or clone to Areca volume set like an other hard drive. You can also directly install the Mac OS X 10.5 Leopard to Areca Intel IOP Based volume set without using the Ghost utility.

- (3). Power up the Mac Pro machine, it will take about 30 seconds for controller firmware ready. This periodic will let the boot up screen blank before Areca volume in the bootable device list.

HARDWARE INSTALLATION

2.3.1 Hot-plug Drive Replacement

The RAID controller supports the ability of performing a hot-swap drive replacement without powering down the system. A disk can be disconnected, removed, or replaced with a different disk without taking the system off-line. The RAID rebuilding will be processed automatically in the background. When a disk is hot swap, the RAID controller may no longer be fault tolerant. Fault tolerance will be lost until the hot swap drive is subsequently replaced and the rebuild operation is completed.

2.3.2 Recognizing a Drive Failure

A drive failure can be identified in one of the following ways:

1. An error status message lists failed drives in the event log.
2. A fault LED illuminates on the front of RAID subsystem if failed drives are inside.

2.3.3 Replacing a Failed Drive

With RAID subsystem drive tray, you can replace a defective physical drive while your computer is still operating. When a new drive has been installed, data reconstruction will be automatically started to rebuild the contents of the disk drive.

Note:

The capacity of the replacement drives must be at least as large as the capacity of the other drives in the raid set. Drives of insufficient capacity will be failed immediately by the RAID adapter without starting the Automatic Data Rebuild.

HARDWARE INSTALLATION

Summary of the Installation

The flow chart below describes the installation procedures for SATA RAID controller. These procedures include hardware installation, the creation and configuration of a RAID volume through the McBIOS/McRAID, OS installation and installation of SATA RAID controller software.

Configuration Utility	Operating System Supported
McBIOS RAID Manager	OS-Independent
McRAID Storage Manager (Via Archttp proxy server)	Windows 2000/XP/2003, Linux, Free-BSD, Solaris and Mac
SAP Monitor (Single Admin Portal to scan for multiple RAID units in the network, Via ArchTtp proxy server)	Windows 2000/XP/2003
SNMP Manager Console Integration	Windows 2000/XP/2003, Linux, Free-BSD

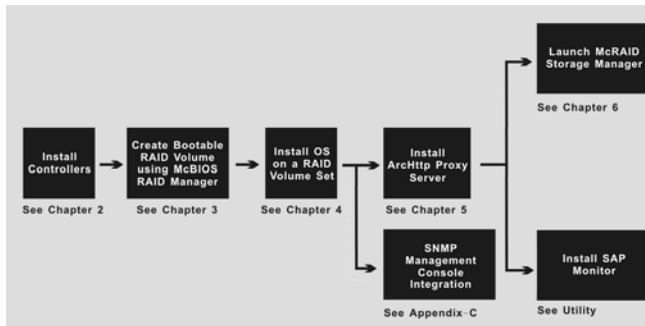

The software components configure and monitor the SATA RAID controller via ArchTtp proxy server.

McRAID Storage Manager

Before launching the firmware-embedded web server, McRAID storage manager, you can to install the ArchTtp proxy server on your server system or through on-board LAN-port (if equipped). If you need additional information about installation and start-up of this function, see the McRAID Storage Manager section in Chapter 6.

HARDWARE INSTALLATION

SNMP Manager Console Integration

- **Out of Band-Using Ethernet Port (12/16/24-port Controller)**

Before launching the firmware-embedded SNMP agent in the sever, you need first to enable the fireware-embedded SNMP agent function on your SATA RAID controller. If you need additional information about installation and start-up this function, see the section 6.8.4 SNMP Configuration (12/16/24-port)

- **In-Band-Using PCI-X/PCIe Bus (4/8/12/16/24-port Controller)**

Before launching the SNMP agent in the sever, you need to enable the fireware-embedded SNMP community configuration first and install Areca SNMP extension agent in your server system. If you need additional information about installation and start-up the function, see the SNMP Operation & Installation section in the Appendix C.

Single Admin Portal (SAP) Monitor

This utility can scan for multiple RAID units on the network and monitor the controller set status. It also includes a disk stress test utility to identify marginal spec disks before putting the RAID unit into a production environment.

For additional information, see the utility manual in the packaged software CD or download it from the web site <http://www.areca.com.tw>

BIOS CONFIGURATION

3. McBIOS RAID Manager

The system mainboard BIOS automatically configures the following SATA RAID controller parameters at power-up:

- I/O Port Address
- Interrupt Channel (IRQ)
- Adapter ROM Base Address

Use McBIOS RAID manager to further configure the SATA RAID controller to suit your server hardware and operating system.

3.1 Starting the McBIOS RAID Manager

This section explains how to use the McBIOS RAID manager to configure your RAID system. The McBIOS RAID manager is designed to be user-friendly. It is a menu-driven program, residing in the firmware, which allows you to scroll through various menus and sub-menus and select among the predetermined configuration options.

When starting a system with an SATA RAID controller installed, it will display the following message on the monitor during the start-up sequence (after the system bios startup screen but before the operating system boots):

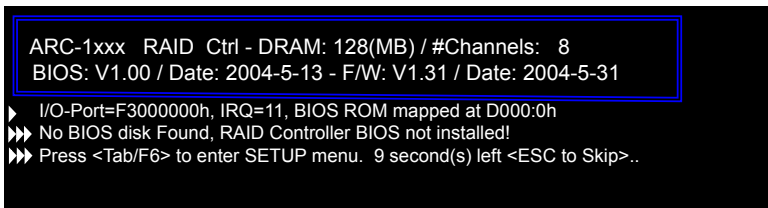

The McBIOS RAID manager message remains on your screen for about nine seconds, giving you time to start the configuration menu by pressing **Tab** or **F6**. If you do not wish to enter configuration menu, press **ESC** to skip configuration immediately. When activated, the McBIOS RAID manager appears showing a selection dialog box listing the SATA RAID controllers that are installed in the system.

The legend at the bottom of the screen shows you what keys are enabled for the screens.

BIOS CONFIGURATION

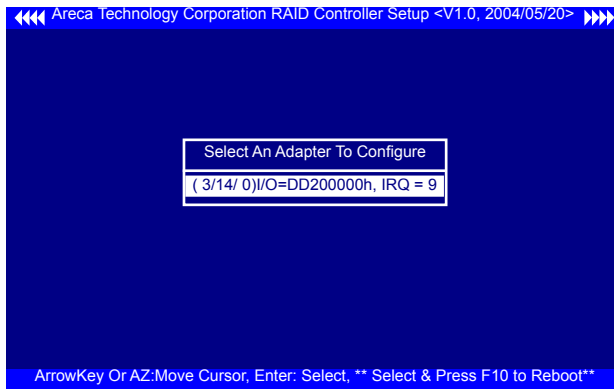

Use the **Up** and **Down** arrow keys to select the adapter you want to configure. While the desired adapter is highlighted, press the **Enter** key to enter the main menu of the McBIOS RAID manager.

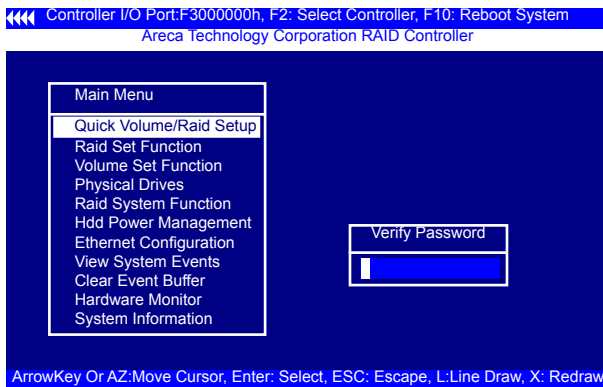

Note:

The manufacture default password is set to **0000**; this password can be modified by selecting **Change Password** in the **Raid System Function** section.

3.2 McBIOS RAID manager

The McBIOS RAID manager is firmware-based and is used to configure RAID sets and volume sets. Because the utility resides in the SATA RAID controller firmware, operation is independent of any operating systems on your computer. This utility can be used to:

- Create RAID sets,
- Expand RAID sets,
- Add physical drives,
- Define volume sets,

BIOS CONFIGURATION

- Modify volume sets,
- Modify RAID level/stripe size,
- Define pass-through disk drives,
- Modify system functions, and
- Designate drives as hot spares.

3.3 Configuring Raid Sets and Volume Sets

You can configure RAID sets and volume sets with McBIOS RAID manager automatically using “Quick Volume/Raid Setup” or manually using “Raid Set/Volume Set Function”. Each configuration method requires a different level of user input. The general flow of operations for RAID set and volume set configuration is:

Step	Action
1	Designate hot spares/pass-through drives (optional).
2	Choose a configuration method.
3	Create RAID sets using the available physical drives.
4	Define volume sets using the space available in the RAID Set.
5	Initialize the volume sets and use volume sets (as logical drives) in the host OS.

3.4 Designating Drives as Hot Spares

Any unused disk drive that is not part of a RAID set can be designated as a hot spare. The “Quick Volume/Raid Setup” configuration will add the spare disk drive and automatically display the appropriate RAID level from which the user can select. For the “Raid Set Function” configuration option, the user can use the “Create Hot Spare” option to define the hot spare disk drive.

When a hot spare disk drive is being created using the “Create Hot Spare” option (in the “Raid Set Function”), all unused physical devices connected to the current controller appear:

Choose the target disk by selecting the appropriate check box.

Press the **Enter** key to select a disk drive, and press **Yes** in the create hot spare to designate it as a hot spare.

BIOS CONFIGURATION

3.5 Using Quick Volume/Raid Setup Configuration

“Quick Volume/Raid Setup” configuration collects all available drives and includes them in a RAID set. The RAID set you create is associated with exactly one volume set. You will only be able to modify the default RAID level, the stripe size, and the capacity of the new volume set. Designating drives as hot spares is also possible in the RAID level selection option. The volume set default settings will be:

Parameter	Setting
Volume Name	Volume Set # 00
SCSI Channel/SCSI ID/SCSI LUN	0/0/0
Cache Mode	Write Back
Tag Queuing	Yes

The default setting values can be changed after configuration is completed. Follow the steps below to create arrays using the “Quick Volume/ Raid Setup” method:

Step	Action
1	Choose “Quick Volume/Raid Setup” from the main menu. The available RAID levels with hot spare for the current volume set drive are displayed.
2	<p>It is recommended that you use drives of the same capacity in a specific array. If you use drives with different capacities in an array, all drives in the RAID set will be set to the capacity of the smallest drive in the RAID set.</p> <p>The numbers of physical drives in a specific array determines which RAID levels that can be implemented in the array.</p> <p>RAID 0 requires 1 or more physical drives.</p> <p>RAID 1 requires at least 2 physical drives.</p> <p>RAID 1+Spare requires at least 3 physical drives.</p> <p>RAID 10 requires at least 4 physical drives.</p> <p>RAID 3 requires at least 3 physical drives.</p> <p>RAID 5 requires at least 3 physical drives.</p> <p>RAID 3 +Spare requires at least 4 physical drives.</p> <p>RAID 5 + Spare requires at least 4 physical drives.</p> <p>RAID 6 requires at least 4 physical drives.</p> <p>RAID 6 + Spare requires at least 5 physical drives.</p> <p>Highlight the desired RAID level for the volume set and press the Enter key to confirm.</p>

BIOS CONFIGURATION

3	The capacity for the current volume set is entered after highlighting the desired RAID level and pressing the Enter key. The capacity for the current volume set is displayed. Use the UP and DOWN arrow keys to set the capacity of the volume set and press the Enter key to confirm. The available stripe sizes for the current volume set are then displayed.
4	Use the UP and DOWN arrow keys to select the current volume set stripe size and press the Enter key to confirm. This parameter specifies the size of the stripes written to each disk in a RAID 0, 1, 10, 5 or 6 volume set. You can set the stripe size to 4 KB, 8 KB, 16 KB, 32 KB, 64 KB, or 128 KB. A larger stripe size provides better read performance, especially when the computer preforms mostly sequential reads. However, if the computer preforms random read requests more often, choose a smaller stripe size.
5	When you are finished defining the volume set, press the Enter key to confirm the "Quick Volume/Raid Setup" function.
6	Foreground (Fast Completion) Press Enter key to define Foreground Initialization or Selected the Background (Instant Available) or No Init. In the Background Initialization, the initialization proceeds as a background task, the volume set is fully accessible for system reads and writes. The operating system can instantly access to the newly created arrays without requiring a reboot and waiting the initialization complete. In Foreground Initialization, the initialization proceeds must be completed before the volume set ready for system accesses. In No Init, there is no initialization on this volume.
7	Initialize the volume set you have just configured.
8	If you need to add additional volume set, using main menu "Create Volume Set" function.

3.6 Using RAID Set/Volume Set Function Method

In "Raid Set Function", you can use the "Create Raid Set Function" to generate a new RAID set. In "Volume Set Function", you can use the "Create Volume Set" function to generate an associated volume set and and configuration parameters.

If the current controller has unused physical devices connected, you can choose the "Create Hot Spare" option in the "Raid Set Function" to define a global hot spare. Select this method to configure new RAID sets and volume sets. The "Raid Set/Volume Set Function" configuration option allows you to associate volume sets with partial and full RAID sets.

BIOS CONFIGURATION

Step	Action
1	To setup the hot spare (option), choose "Raid Set Function" from the main menu. Select the "Create Hot Spare" and press the Enter key to define the hot spare.
2	Choose "RAID Set Function" from the main menu. Select "Create Raid Set" and press the Enter key.
3	The "Select a Drive For Raid Set" window is displayed showing the SATA drives connected to the SATA RAID controller.
4	Press the UP and DOWN arrow keys to select specific physical drives. Press the Enter key to associate the selected physical drive with the current RAID set. It is recommended that you drives of the same capacity in a specific array. If you use drives with different capacities in an array, all drives in the RAID set will be set to the capacity of the smallest drive in the RAID set. The numbers of physical drives in a specific array determines which RAID levels that can be implemented in the array. RAID 0 requires 1 or more physical drives. RAID 1 requires at least 2 physical drives. RAID 10 requires at least 4 physical drives. RAID 3 requires at least 3 physical drives. RAID 5 requires at least 3 physical drives. RAID 6 requires at least 4 physical drives.
5	After adding the desired physical drives to the current RAID set, press Yes to confirm the "Create Raid Set" function.
6	An "Edit The Raid Set Name" dialog box appears. Enter 1 to 15 alphanumeric characters to define a unique identifier for this new raid set. The default raid set name will always appear as Raid Set. #. Press Enter to finish the name editing.
7	Press the Enter key when you are finished creating the current RAID set. To continue defining another RAID set, repeat step 3. To begin volume set configuration, go to step 8.
8	Choose the "Volume Set Function" from the main menu. Select "Create Volume Set" and press the Enter key.
9	Choose a RAID set from the "Create Volume From Raid Set" window. Press the Enter key to confirm the selection.
10	Choosing Foreground (Fast Completion) or Background (Instant Availability) initialization or No Init (To Rescue Volume): during Background Initialization, the initialization proceeds as a background task and the volume set is fully accessible for system reads and writes. The operating system can instantly access the newly created arrays without requiring a reboot and waiting for initialization complete. In Foreground Initialization, the initialization must be completed before the volume set is ready for system accesses. In Fast Initialization, initiation is completed more quickly but volume access by the operating system is delayed. When No Init, there is no initialization on this volume.

BIOS CONFIGURATION

- 11 If space remains in the raid set, the next volume set can be configured. Repeat steps 8 to 10 to configure another volume set.

Note:

The "Modify Volume Set" method provides the same functions as the "Create Volume Set" configuration method. In the "Volume Set function", you can use "Modify Volume Set" to change all volume set parameters except for capacity (size).

3.7 Main Menu

The main menu shows all functions that are available for executing actions, which is accomplished by clicking on the appropriate link.

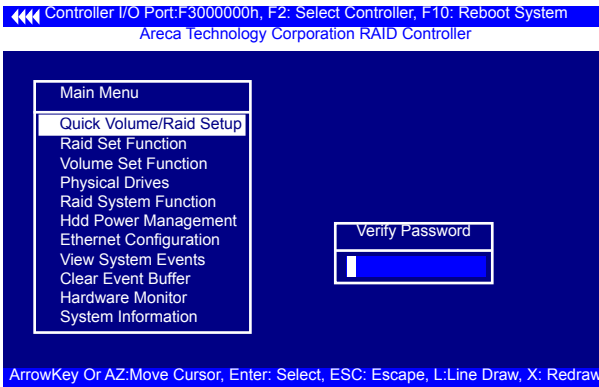

Note:

The manufacture default password is set to **0000**; this password can be modified by selecting **Change Password** in the **Raid System Function** section.

Option	Description
Quick Volume/Raid Setup	Create a default configuration based on the number of physical disk installed
Raid Set Function	Create a customized RAID set
Volume Set Function	Create a customized volume set
Physical Drives	View individual disk information
Raid System Function	Setup the RAID system configuration
Hdd Power Management	Manage HDD power based on usage patterns
Ethernet Configuration	Ethernet LAN setting (12/16/24 ports only)
View System Events	Record all system events in the buffer

BIOS CONFIGURATION

Clear Event Buffer	Clear all information in the event buffer
Hardware Monitor	Show the hardware system environment status
System Information	View the controller system information

This password option allows user to set or clear the RAID controller's password protection feature. Once the password has been set, the user can only monitor and configure the raid controller by providing the correct password. The password is used to protect the internal RAID controller from unauthorized entry. The controller will only prompt for the password when entering the main menu from the initial screen. The SATA RAID controller will automatically return to the initial screen when it does not receive any command in twenty seconds.

3.7.1 Quick Volume/RAID Setup

"Quick Volume/RAID Setup" is the fastest way to prepare a RAID set and volume set. It requires only a few keystrokes to complete. Although disk drives of different capacity may be used in the RAID set, it will use the capacity of the smallest disk drive as the capacity of all disk drives in the RAID set. The "Quick Volume/RAID Setup" option creates a RAID set with the following properties:

1. All of the physical drives are contained in one RAID set.
2. The RAID level, hot spare, capacity, and stripe size options are selected during the configuration process.
3. When a single volume set is created, it can consume all or a portion of the available disk capacity in this RAID set.
4. If you need to add an additional volume set, use the main menu "Create Volume Set" function.

The total number of physical drives in a specific RAID set determine the RAID levels that can be implemented within the RAID Set. Select "Quick Volume/RAID Setup" from the main menu; all possible RAID level will be displayed on the screen.

BIOS CONFIGURATION

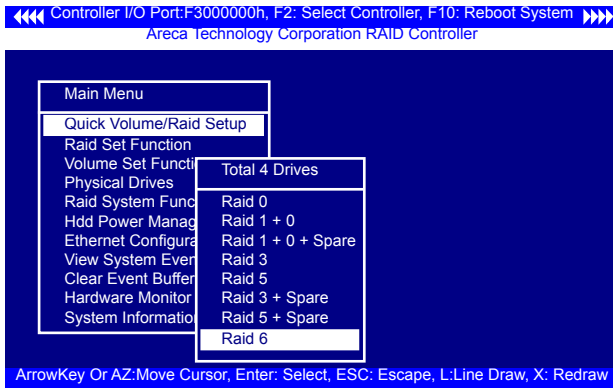

If volume capacity will exceed 2TB, controller will show the "Greater Two TB Volume Support" sub-menu.

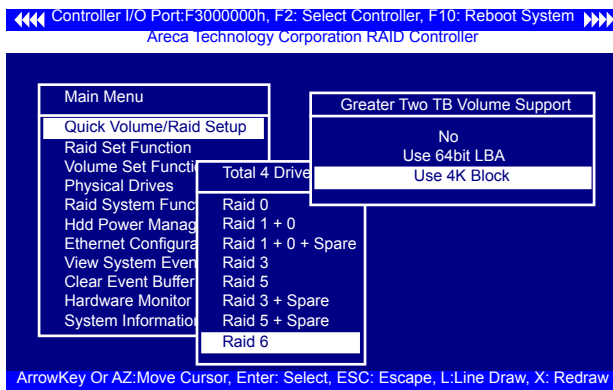

- **No**

It keeps the volume size with max. 2TB limitation.

- **LBA 64**

This option use 16 bytes CDB instead of 10 bytes. The maximum volume capacity supports up to 512TB.

This option works on different OS which supports 16 bytes CDB. Such as:

Windows 2003 with SP1

Linux kernel 2.6.x or latter

BIOS CONFIGURATION

- **Use 4K Block**

It change the sector size from default 512 Bytes to 4k Bytes. the maximum volume capacity up to 16TB.

This option works under Windows platform only. And it can not be converted to "Dynamic Disk", because 4k sector size is not a standard format.

For more details please download PDF file from ftp://ftp.areca.com.tw/RaidCards/Documents/Manual_Spec/Over2TB_050721.zip

A single volume set is created and consumes all or a portion of the disk capacity available in this RAID set. Define the capacity of volume set in the "Available Capacity" popup. The default value for the volume set, which is 100% of the available capacity, is displayed in the selected capacity. Use the **UP** and **DOWN** keys to select the capacity, press the **Enter** key to accept this value. If the volume set uses only part of the RAID set capacity, you can use the "Create Volume Set" option in the main menu to define additional volume sets.

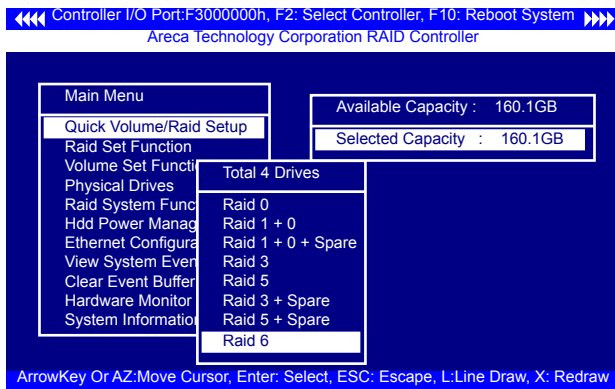

Stripe Size This parameter sets the size of the stripe written to each disk in a RAID 0, 1, 10, 5, or 6 logical drive. You can set the stripe size to 4 KB, 8 KB, 16 KB, 32 KB, 64 KB, or 128 KB.

BIOS CONFIGURATION

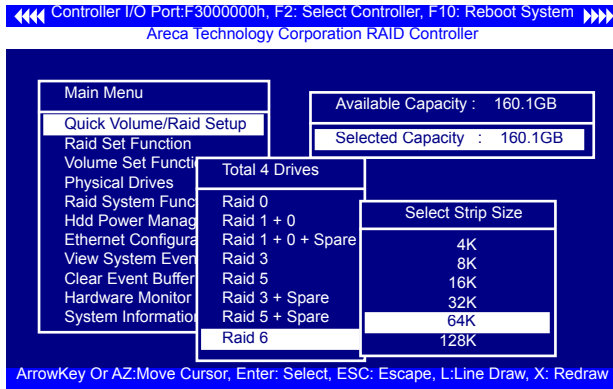

A larger stripe size produces better-read performance, especially if your computer does mostly sequential reads. However, if you are certain that your computer performs random reads more often, select a smaller stripe size.

Press the **Yes** option in the "Create Vol/Raid Set" dialog box, the RAID set and volume set will start to initialize it.

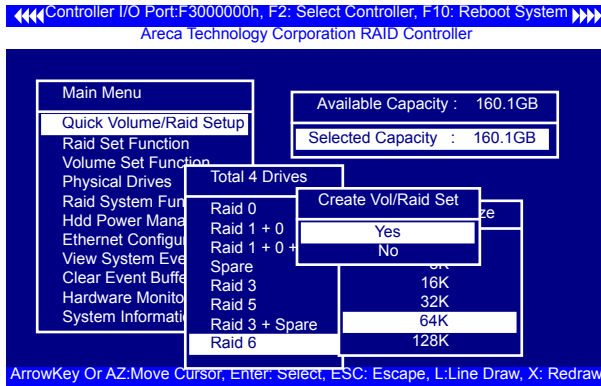

Select "Foreground (Faster Completion)" or "Background (Instant Available)" for initialization. "No Init (To Rescue Volume)" for recovering the missing RAID set configuration.

BIOS CONFIGURATION

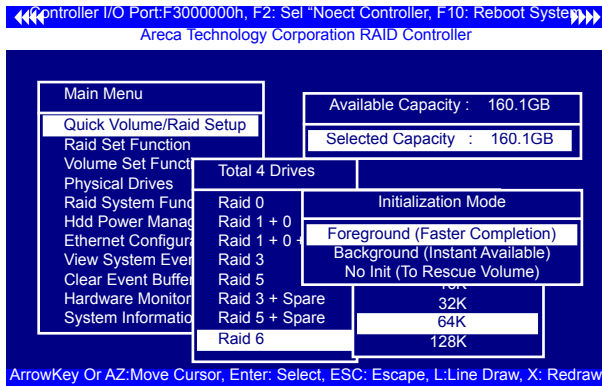

3.7.2 Raid Set Function

Manual configuration gives complete control of the RAID set setting, but it will take longer to configure than "Quick Volume/Raid Setup" configuration. Select "Raid Set Function" to manually configure the RAID set for the first time or delete existing RAID sets and reconfigure the RAID set.

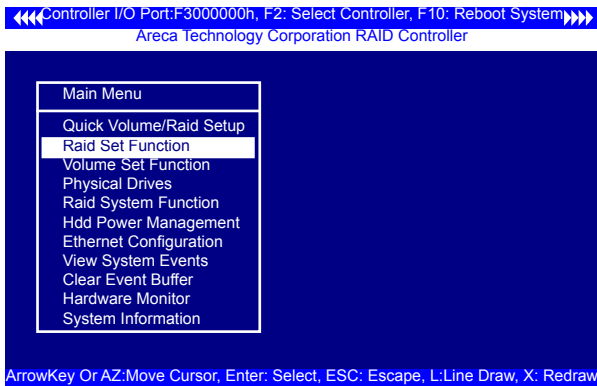

3.7.2.1 Create Raid Set

To define a RAID set, follow the procedure below:

1. Select "Raid Set Function" from the main menu.
2. Select "Create Raid Set " from the "Raid Set Function" dialog box.

BIOS CONFIGURATION

3. A "Select SATA Drive For Raid set" window is displayed showing the SATA drives connected to the current controller. Press the **UP** and **DOWN** arrow keys to select specific physical drives. Press the **Enter** key to associate the selected physical drive with the current RAID set. Repeat this step; the user can add as many disk drives as are available to a single RAID set.

When finish selecting SATA drives for RAID set, press the **Esc** key. A "Create Raid Set Confirmation" screen appears, select the **Yes** option to confirm it.

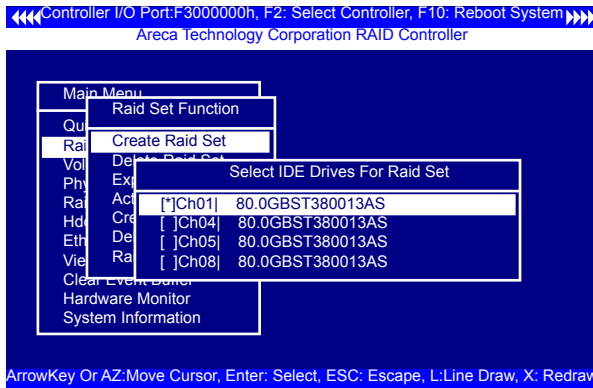

4. An "Edit The Raid Set Name" dialog box appears. Enter 1 to 15 alphanumeric characters to define a unique identifier for the RAID set. The default RAID set name will always appear as Raid Set. #.

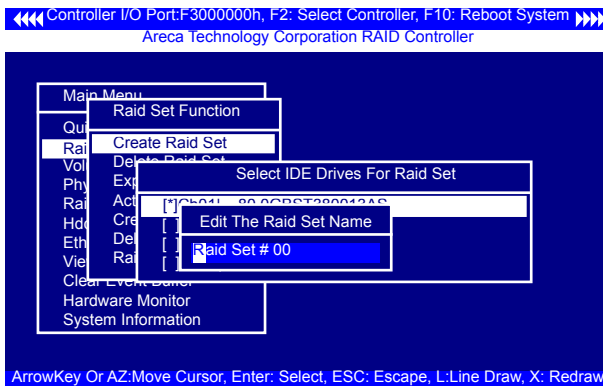

BIOS CONFIGURATION

3.7.2.2 Delete Raid Set

To erase and reconfigure a RAID set completely, you must delete it and re-create the RAID set first. To delete a RAID set, select the RAID set number that user want to delete in the "Select Raid Set to Delete" screen. The "Delete Raid Set" dialog box appears, then press **Yes** option to delete it. Please noticed data on RAID set will be lost if this option is used.

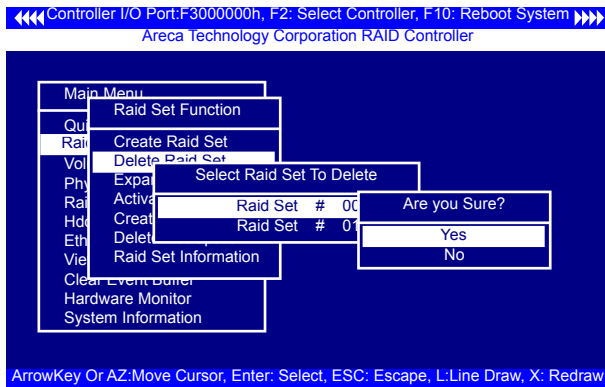

3.7.2.3 Expand Raid Set

Instead of deleting a RAID set and recreating it with additional disk drives, the "Expand Raid Set" function allows the users to add disk drives to the RAID set that have already been created. To expand a RAID set:

Select the "Expand Raid Set" option. If there is an available disk, then the "Select SATA Drives For Raid Set Expansion" screen appears.

Select the target RAID set by clicking on the appropriate radio button. Select the target disk by clicking on the appropriate check box.

Press the **Yes** option to start the expansion on the RAID set.

The new additional capacity can be utilized by one or more volume sets. The volume sets associated with this RAID set appear for you to have chance to modify RAID level or stripe size. Follow the instruction presented in the "Modify Volume Set" to modify the volume sets; operation system specific utilities may be required to expand operating system partitions.

BIOS CONFIGURATION

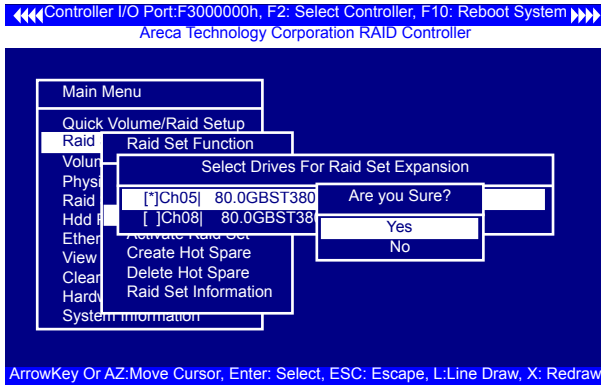

Note:

1. Once the "Expand Raid Set" process has started, user can not stop it. The process must be completed.
2. If a disk drive fails during raid set expansion and a hot spare is available, an auto rebuild operation will occur after the RAID set expansion completes.
3. RAID set expansion is a quite critical process, we strongly recommend customer backup data before expand. Unexpected accident may cause serious data corruption.

● Migrating

Migration occurs when a disk is added to a RAID set. Migrating state is displayed in the RAID state area of "The Raid Set Information" screen when a disk is being added to a RAID set. Migrating state is also displayed in the associated volume state area of the "Volume Set Information" which belongs this RAID set.

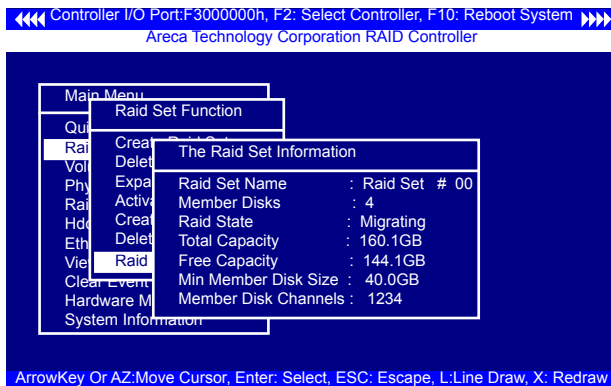

BIOS CONFIGURATION

3.7.2.4 Activate Incomplete Raid Set

The following screen is used to activate the RAID set after one of its disk drive was removed in the power off state. When one of the disk drives is removed in power off state, the RAID set state will change to "Incomplete State". If a user wants to continue to work while the SATA RAID controller is powered on, the user can use the "Activate Raid Set" option to activate the RAID set. After user selects this function, the RAID state will change to "Degraded Mode".

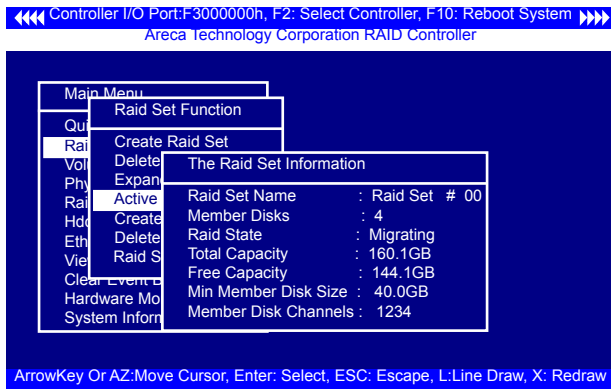

3.7.2.5 Create Hot Spare

When you choose the "Create Hot Spare" option in the "Raid Set Function", all unused physical devices connected to the current controller will result in the following:

Select the target disk by clicking on the appropriate check box. Press the **Enter** key to select a disk drive and press **Yes** option in the "Create Hot Spare" to designate it as a hot spare.

The "Create Hot Spare" option gives you the ability to define a global hot spare.

BIOS CONFIGURATION

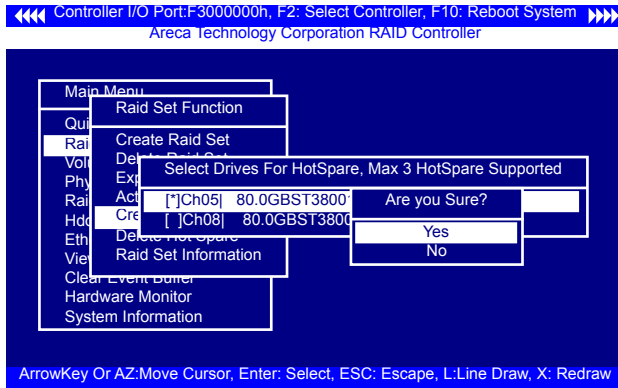

3.7.2.6 Delete Hot Spare

Select the target hot spare disk to delete by clicking on the appropriate check box.

Press the **Enter** keys to select a hot spare disk drive, and press **Yes** in the "Delete Hot Spare" screen to delete the hot spare.

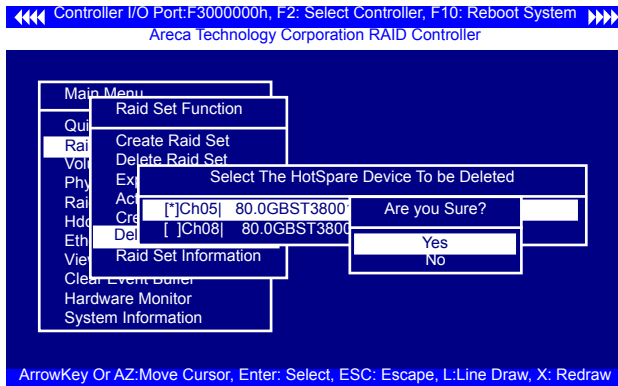

BIOS CONFIGURATION

3.7.2.7 Raid Set Information

To display RAID set information, move the cursor bar to the desired RAID set number, then press the **Enter** key. The "Raid Set Information" will display. You can only view information for the RAID set in this screen.

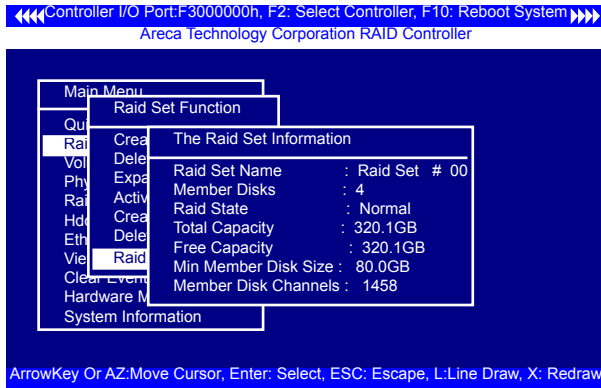

3.7.3 Volume Set Function

A volume set is seen by the host system as a single logical device; it is organized in a RAID level within the controller utilizing one or more physical disks. RAID level refers to the level of data performance and protection of a volume set. A volume set can consume all of the capacity or a portion of the available disk capacity of a RAID set. Multiple volume sets can exist on a RAID set. If multiple volume sets reside on a specified RAID set, all volume sets will reside on all physical disks in the RAID set. Thus each volume set on the RAID set will have its data spread evenly across all the disks in the RAID set. This is with regards in having more than one volume set using some of the available disks and another volume set using other disks.

BIOS CONFIGURATION

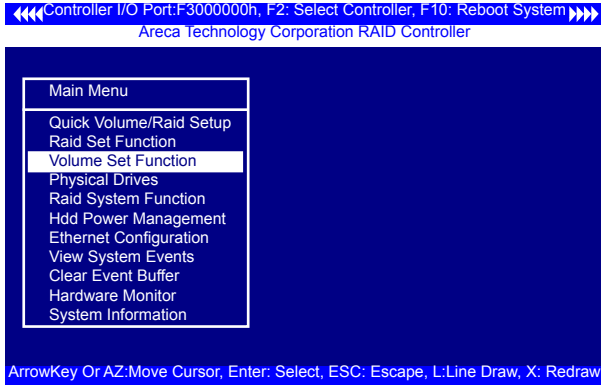

3.7.3.1 Create Volume Set

1. Volume sets of different RAID levels may coexist on the same RAID set.
2. Up to 16 volume sets can be created by the SATA RAID controller.
3. The maximum addressable size of a single volume set is not limited to 2TB because the controller is capable of 64-bit mode. However, the operating system itself may not be capable of addressing more than 2TB.

To create a volume set, follow the following steps:

1. Select the "Volume Set Function" from the main menu.
2. Choose the "Create Volume Set" from "Volume Set Functions" dialog box screen.

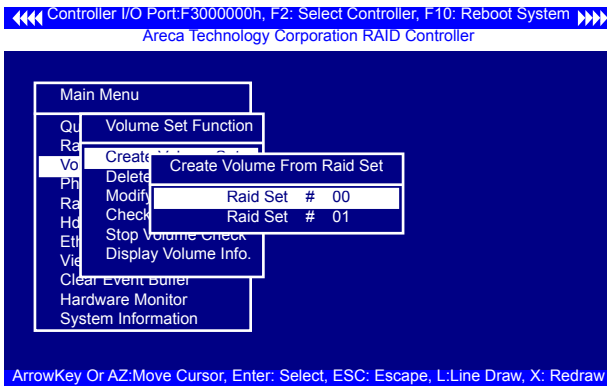

BIOS CONFIGURATION

3. The "Create Volume From RAID Set" dialog box will be appeared. This screen displays the existing arranged RAID sets. Select the RAID set number and press the **Enter** key. The "Volume Creation" dialogue is displayed in the screen.
4. A window with a summary of the current volume set's settings. The "Volume Creation" option allows user to select the Volume Name, Capacity, RAID Level, Strip Size, SCSI Channel/SCSI ID/SCSI LUN, Cache Mode and Tag Queuing. The user can modify the default values in this screen; the modification procedures are in section 3.5.3.3.

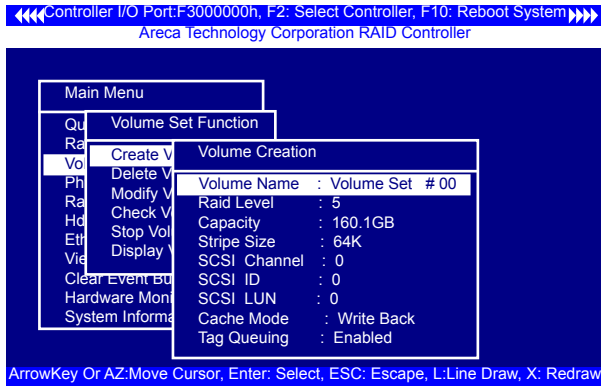

5. After completing the modification of the volume set, press the **Esc** key to confirm it. An "Initialization" screen is presented.
 - Select "Foreground (Faster Completion)" for faster initialization of the selected volume set.
 - Select "Background (Instant Available)" for normal initialization of the selected volume set.

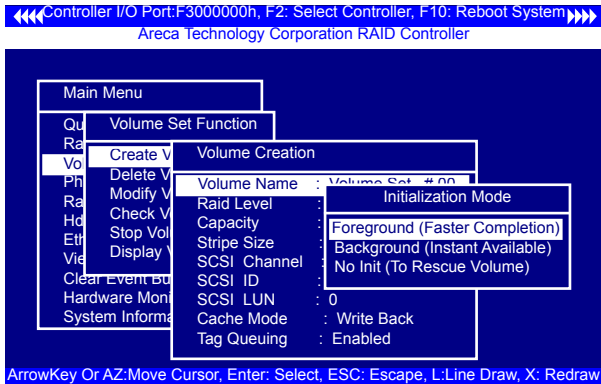

BIOS CONFIGURATION

- Select "No Init (To Rescue Volume)" for no initialization of the selected volume set.
6. Repeat steps 3 to 5 to create additional volume sets.
 7. The initialization percentage of volume set will be displayed at the button line.

• Volume Name

The default volume name will always appear as Volume Set #. You can rename the volume set providing it does not exceed the 15 characters limit.

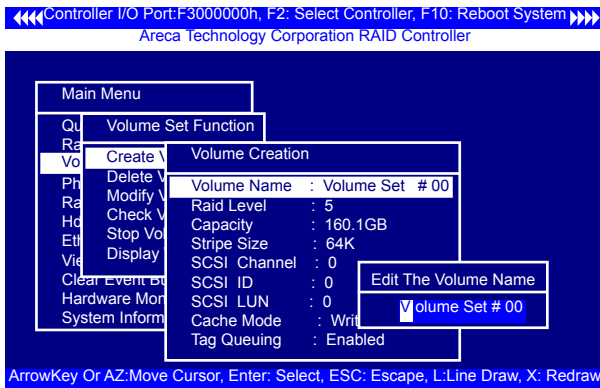

• Raid Level

Set the RAID level for the volume set. Highlight RAID Level and press **Enter**.

The available RAID levels for the current volume set are displayed. Select a RAID level and press the **Enter** key to confirm.

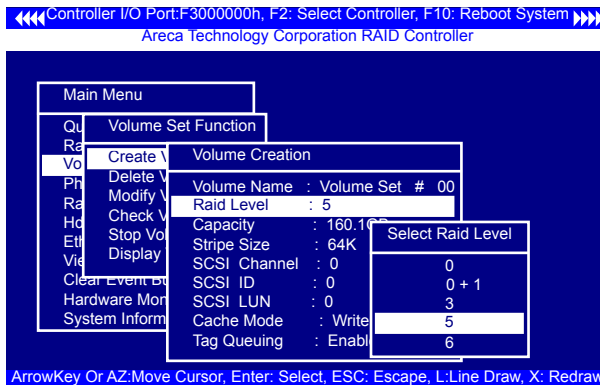

BIOS CONFIGURATION

• Capacity

The maximum available volume size is the default value for the first setting. Enter the appropriate volume size to fit your application. The capacity value can be increased or decreased by the **UP** and **DOWN** arrow keys. The capacity of each volume set must be less than or equal to the total capacity of the RAID set on which it resides.

If volume capacity will exceed 2TB, controller will show the "Greater Two TB Volume Support" sub-menu.

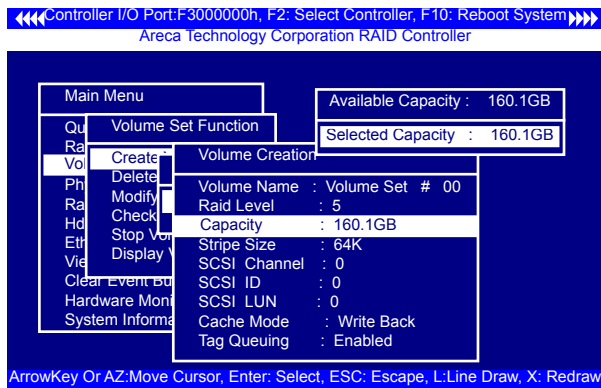

• No

It keeps the volume size with max. 2TB limitation.

• LBA 64

This option uses 16 bytes CDB instead of 10 bytes. The maximum volume capacity supports up to 512TB.

This option works on different OS which supports 16 bytes CDB.

Such as:

Windows 2003 with SP1

Linux kernel 2.6.x or latter

• Use 4K Block

It change the sector size from default 512 Bytes to 4k Bytes. the maximum volume capacity up to 16TB.

This option works under Windows platform only. And it can not be converted to Dynamic Disk, because 4k sector size is not a standard format.

BIOS CONFIGURATION

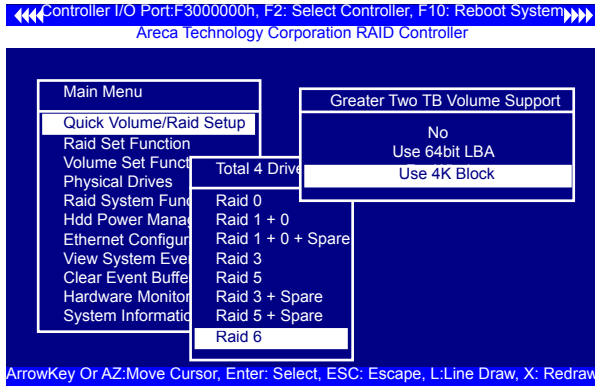

For more details please download PDF file from ftp://ftp.areca.com.tw/RaidCards/Documents/Manual_Spec/Over2TB_050721.zip

• Stripe Size

This parameter sets the size of segment written to each disk in a RAID 0, 1, 10, 5, or 6 logical drive. You can set the stripe size to 4 KB, 8 KB, 16 KB, 32 KB, 64 KB, or 128 KB.

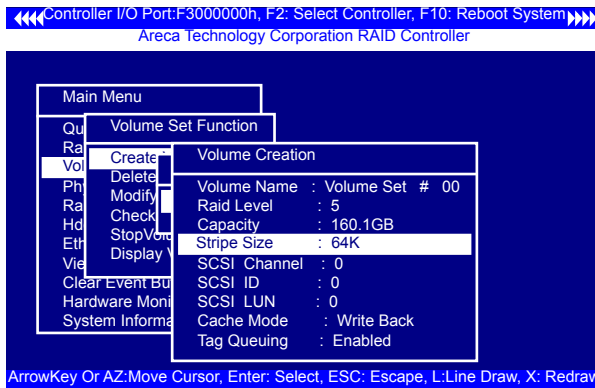

• SCSI Channel

The SATA RAID controller function simulates a SCSI RAID controller. The host bus represents the SCSI channel. Choose the "SCSI Channel". A "Select SCSI Channel" dialog box will appear; select the channel number and press the **Enter** key to confirm it.

BIOS CONFIGURATION

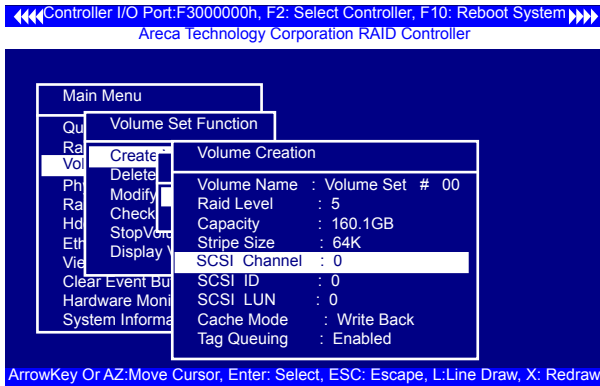

• SCSI ID

Each device attached to the SATA card, as well as the card itself, must be assigned a unique SCSI ID number. A SCSI channel can connect up to 15 devices. It is necessary to assign a SCSI ID to each device from a list of available SCSI IDs.

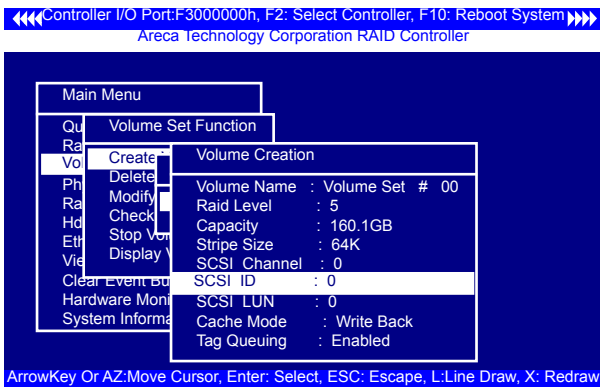

• SCSI LUN

Each SCSI ID can support up to 8 LUNs. Most SATA controllers treat each LUN as if it were a SATA disk.

BIOS CONFIGURATION

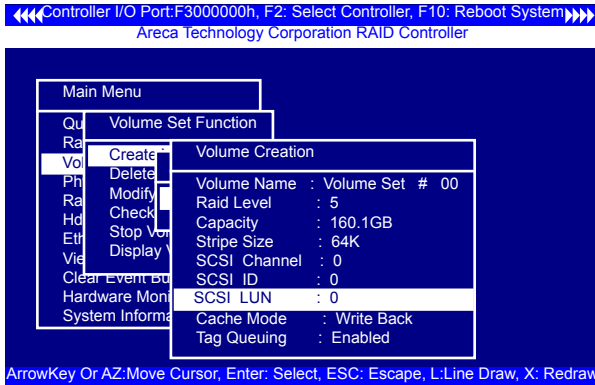

• Cache Mode

User can set the cache mode to either “Write Through” or “Write Back” cache.

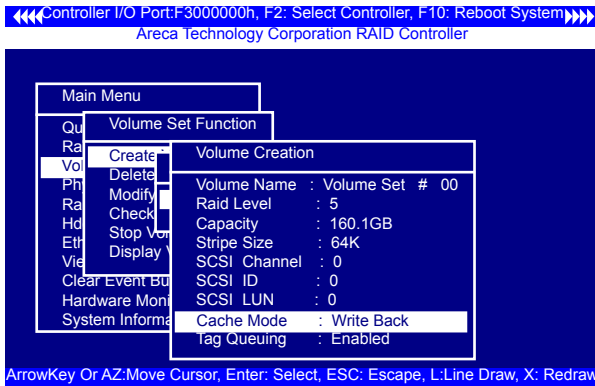

• Tag Queuing

This option, when enabled, can enhance overall system performance under multi-tasking operating systems. The Command Tag (Drive Channel) function controls the SCSI command tag queuing support for each drive channel. This function should normally remain enabled. Disable this function only when using older drives that do not support command tag queuing.

BIOS CONFIGURATION

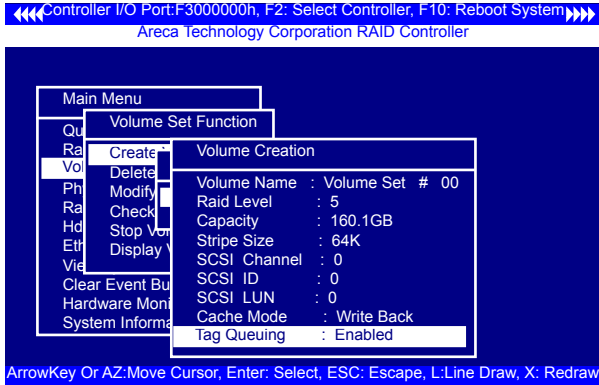

3.7.3.2 Delete Volume Set

To delete volume set from a RAID set, move the cursor bar to the "Delete Volume Set" item, then press the **Enter** key. The "Volume Set Functions" menu will show all Raid Set # items. Move the cursor bar to a RAID set number, then press the **Enter** key to show all volume sets within that RAID set. Move the cursor to the volume set number that is to be deleted and press **Enter** key to delete it.

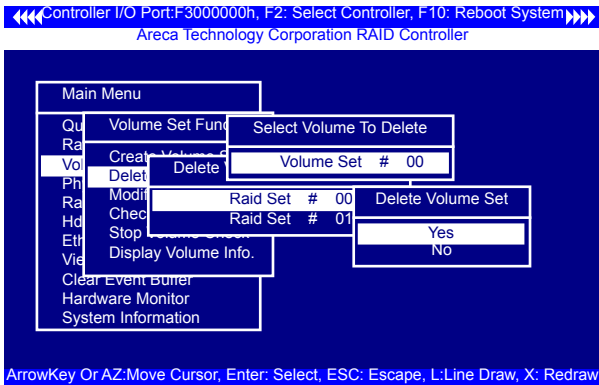

BIOS CONFIGURATION

3.7.3.3 Modify Volume Set

Use this option to modify volume set configuration. To modify volume set values from RAID set system function, move the cursor bar to the "Modify Volume Set" item, then press the **Enter** key. The "Volume Set Functions" menu will show all RAID set items. Move the cursor bar to a RAID set number item, then press the **Enter** key to show all volume set items. Select the volume set from the list to be changed, press the **Enter** key to modify it.

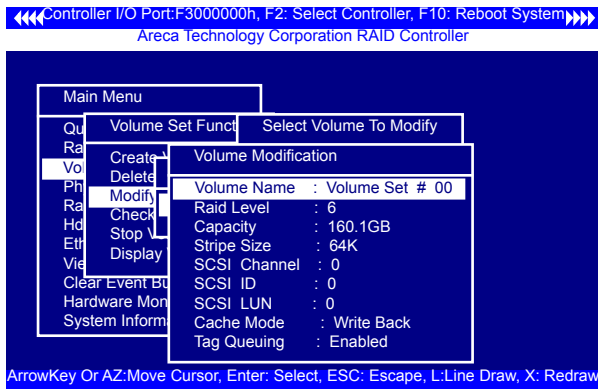

As shown, volume information can be modified at this screen. Choose this option to display the properties of the selected volume set; all values can be modified except only the last volume set capacity of the expand RAID set.

3.7.3.3.1 Volume Growth

Use "Expand RAID Set" function to add disk to a RAID set. The additional capacity can be used to enlarge the last volume set size or to create another volume set. The "Modify Volume Set" function can support the "Volume Modification" function. To expand the last volume set capacity, move the cursor bar to the "Capacity" item and enter the capacity size. When finished the above action, press the **ESC** key and select the **Yes** option to complete the action. The last volume set starts to expand its capacity.

BIOS CONFIGURATION

To expand an existing volume noticed:

- Only the last volume can expand capacity.
- When expand volume capacity, you can't modify stripe size or modify RAID level simultaneously.
- You can expand volume capacity, but can't reduce volume capacity size.
- After volume expansion, the volume capacity can't be decreased.

For greater 2TB expansion:

- If your system installed in the volume, don't expand the volume capacity greater 2TB, currently OS can't support boot up from a greater 2TB capacity device.
- Expand over 2TB used LBA64 mode. Please make sure your OS supports LBA64 before expand it.

3.7.3.3.2 Volume Set Migration

Migrating occurs when a volume set is migrating from one RAID level to another, when a volume set strip size changes, or when a disk is added to a RAID set. Migration status is displayed in the volume state area of the "Volume Set Information" screen.

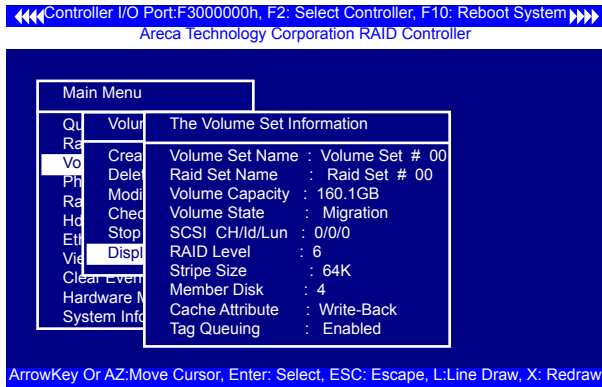

BIOS CONFIGURATION

3.7.3.4 Check Volume Set

Use this option to verify the correctness of the redundant data in a volume set. For example, in a system with a dedicated parity disk drive, a volume set check entails computing the parity of the data disk drives and comparing those results to the contents of the dedicated parity disk drive. To check volume set, move the cursor bar to the "Check Volume Set" item, then press the **Enter** key. The "Volume Set Functions" menu will show all RAID set number items. Move the cursor bar to a RAID set number item and then press the **Enter** key to show all volume set items. Select the volume set to be checked from the list and press **Enter** key to select it. After completing the selection, the confirmation screen appears, press **Yes** option to start the check.

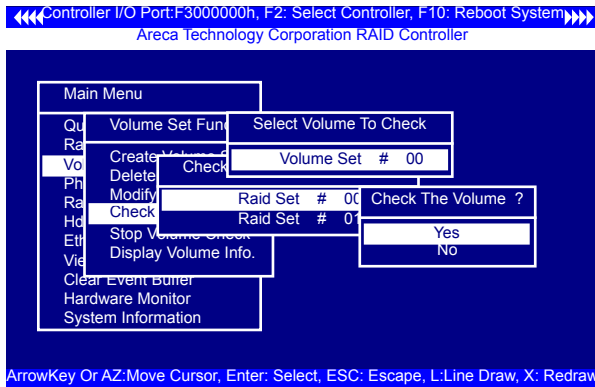

3.7.3.5 Stop Volume Set Check

Use this option to stop all of the "Check Volume Set" operations.

3.7.3.6 Display Volume Set Info.

To display volume set information, move the cursor bar to the desired volume set number and then press the **Enter** key. The "Volume Set Information" screen will be shown. You can only view the information of this volume set in this screen.

BIOS CONFIGURATION

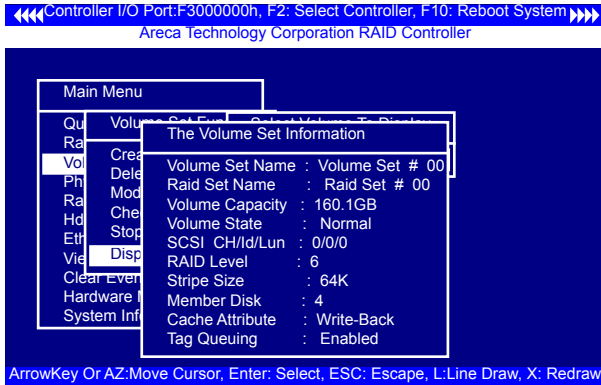

3.7.4 Physical Drives

Choose this option from the main menu to select a physical disk and perform the operations listed below.

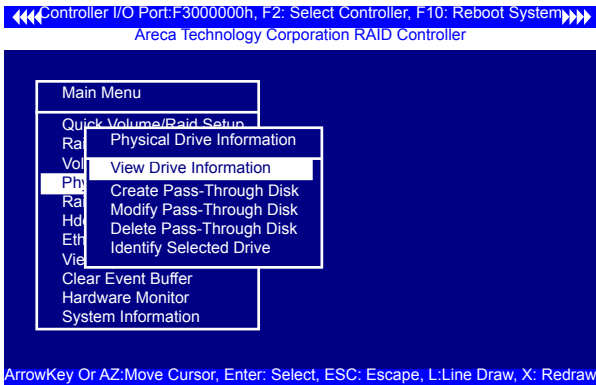

3.7.4.1 View Drive Information

When you choose this option, the physical disks connected to the SATA RAID controller are listed. Move the cursor to the desired drive and press Enter to view drive information.

BIOS CONFIGURATION

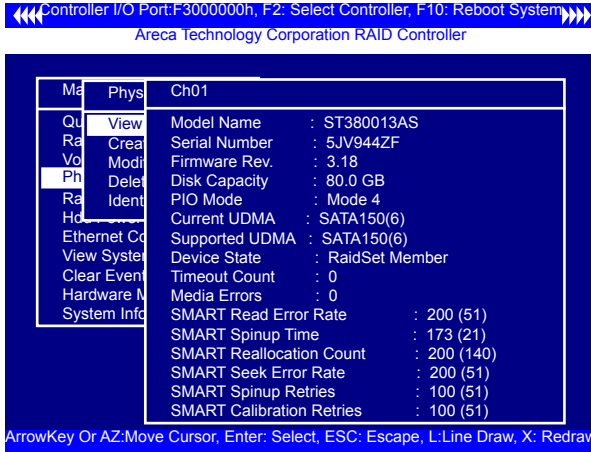

3.7.4.2 Create Pass-Through Disk

A pass-through disk is not controlled by the SATA RAID controller firmware and thus can not be a part of a volume set. The disk is available directly to the operating system as an individual disk. It is typically used on a system where the operating system is on a disk not controlled by the SATA RAID controller firmware. The SCSI Channel, SCSI ID, SCSI LUN, Cache Mode, and Tag Queuing must be specified to create a pass-through disk.

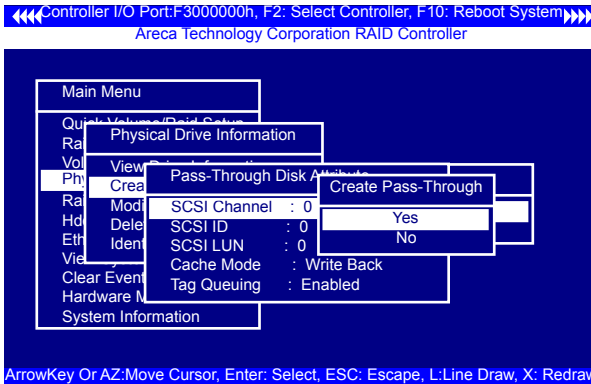

BIOS CONFIGURATION

3.7.4.3 Modify a Pass-Through Disk

Use this option to modify pass-through disk attributes. To select and modify a pass-through disk from the pool of pass-through disks, move the cursor bar to the "Modify Pass-Through Drive" option and then press the **Enter** key. The "Physical Drive Function" menu will show all pass-through drive number options. Move the cursor bar to the desired item and then press the **Enter** key to show all pass-through disk attributes. Select the parameter from the list to be changed and then press the **Enter** key to modify it.

3.7.4.4 Delete Pass-Through Disk

To delete a pass-through drive from the pass-through drive pool, move the cursor bar to the "Delete Pass-Through Drive" item, then press the **Enter** key. The "Delete Pass-Through confirmation" screen will appear; select **Yes** option to delete it.

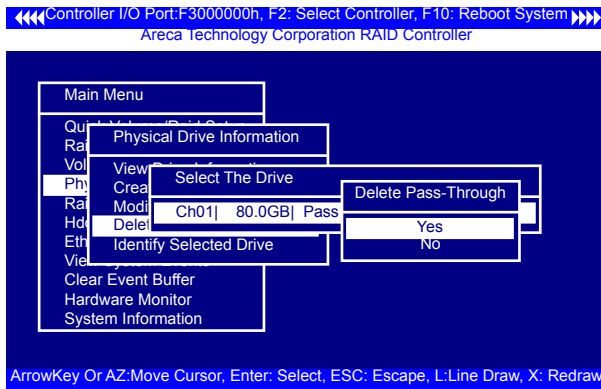

3.7.4.5 Identify Selected Drive

You can use the "Identify Selected Drive" feature to prevent removing the wrong drive, the selected drive fault LED will blink when the "Identify Selected Drive" is selected.

BIOS CONFIGURATION

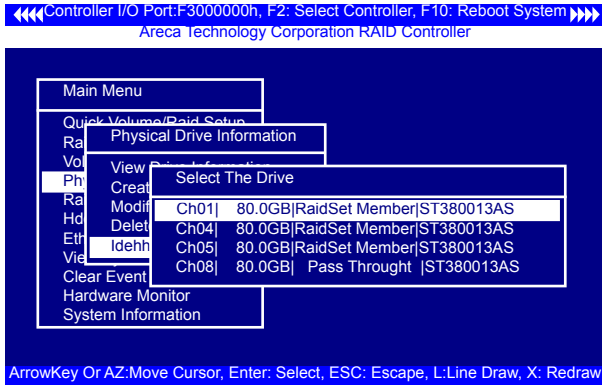

3.7.5 Raid System Function

To set the RAID system function, move the cursor bar to the main menu and select the "Raid System Function" item and then press **Enter** key. The "Raid System Function" menu will show multiple items. Move the cursor bar to an item, then press **Enter** key to select the desired function.

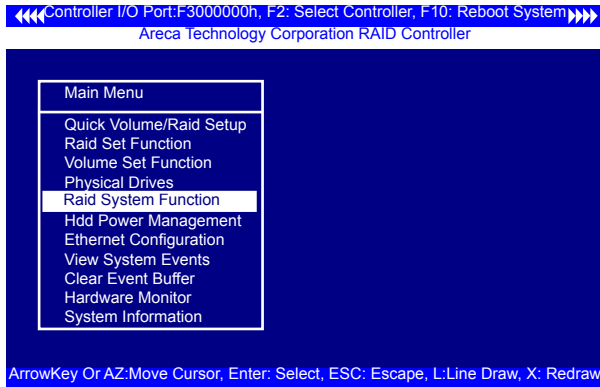

BIOS CONFIGURATION

3.7.5.1 Mute The Alert Beeper

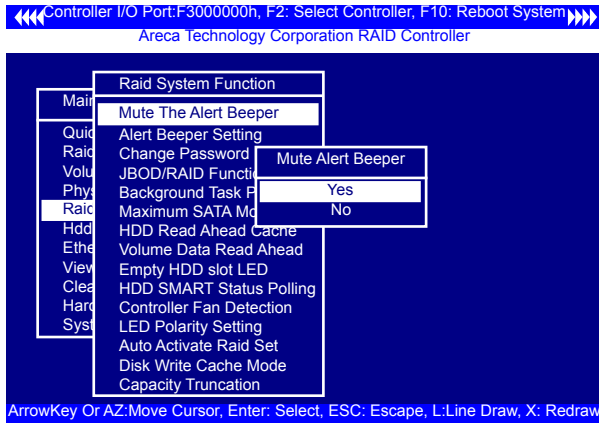

The “Mute The Alert Beeper” function item is used to control the SATA RAID controller beeper. Select **Yes** option and press the **Enter** key in the dialog box to turn the beeper off temporarily. The beeper will still activate on the next event.

3.7.5.2 Alert Beeper Setting

The “Alert Beeper Setting” item is used to “Disabled or “Enable” the SATA RAID controller alarm tone generator. Select “Disabled” and press the **Enter** key in the dialog box to turn the beeper off.

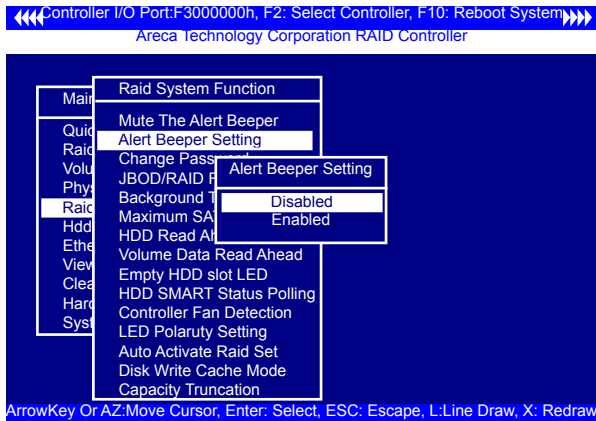

BIOS CONFIGURATION

3.7.5.3 Change Password

The manufacture default password is set to **0000**. The password option allows user to set or clear the password protection feature. Once the password has been set, the user can monitor and configure the controller only by providing the correct password. This feature is used to protect the SATA RAID system from unauthorized access. The controller will check the password only when entering the main menu from the initial screen. The system will automatically go back to the initial screen if it does not receive any command in 5 minutes. Do not use spaces when you enter the password, If spaces are used, it will lock out the user.

To set or change the password, move the cursor to "Raid System Function" screen, press the "Change Password" item. The "Enter New Password" screen will appear.

To disable the password, only press **Enter** key in both the "Enter New Password" and "Re-Enter New Password" column. The existing password will be cleared. No password checking will occur when entering the main menu.

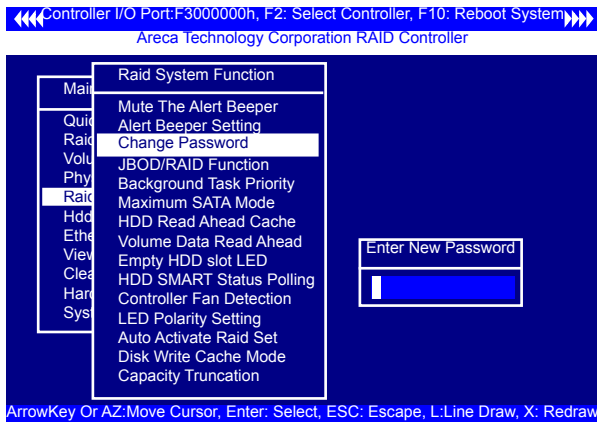

BIOS CONFIGURATION

3.7.5.4 JBOD/RAID Function

JBOD is an acronym for “Just a Bunch Of Disk”. A group of hard disks in a RAID controllers are not set up as any type of RAID configuration. All drives are available to the operating system as an individual disk. JBOD does not provide data redundancy. User needs to delete the RAID set, when you want to change the option from the RAID to the JBOD function.

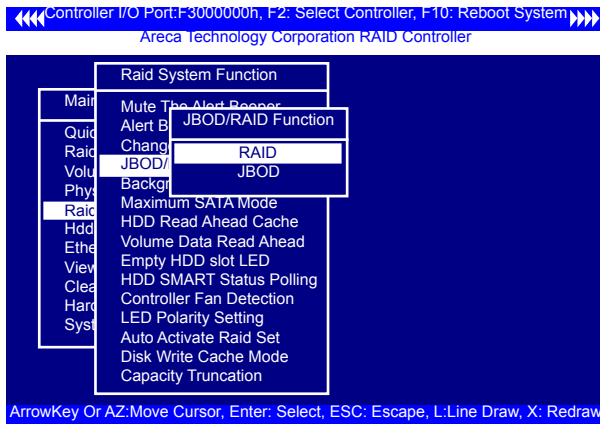

3.7.5.5 Background Task Priority

The “Background Task Priority” is a relative indication of how much time the controller devotes to a rebuild operation. The SATA RAID controller allows the user to choose the rebuild priority (Ultralow, Low, Normal, High) to balance volume set access and rebuild tasks appropriately.

BIOS CONFIGURATION

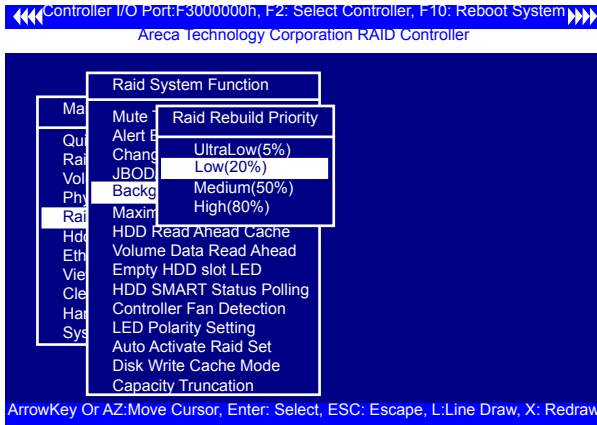

3.7.5.6 Maximum SATA Mode

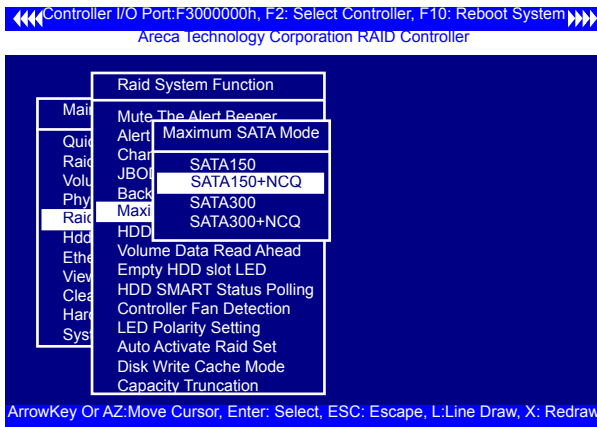

The SATA RAID controller can support up to SATA II, which runs up to 300MB/s, twice as fast as SATA150. NCQ is a command protocol in Serial ATA that can only be implemented on native Serial ATA hard drives. It allows multiple commands to be outstanding within a drive at the same time. Drives that support NCQ have an internal queue where outstanding commands can be dynamically rescheduled or re-ordered, along with the necessary tracking mechanisms for outstanding and completed portions of the workload. The SATA RAID controller allows the user to choose the SATA Mode: SATA150, SATA150+NCQ, SATA300, SATA300+NCQ.

BIOS CONFIGURATION

3.7.5.7 HDD Read Ahead Cache

Allow Read Ahead (Default: Enabled)—When Enabled, the drive's read ahead cache algorithm is used, providing maximum performance under most circumstances.

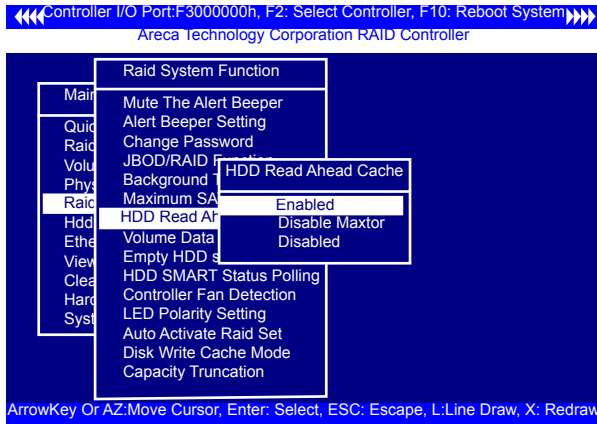

3.7.5.8 Volume Data Read Ahead

The volume read data ahead parameter specifies the controller firmware algorithms which process the Read Ahead data blocks from the disk. The Read Ahead parameter is normal by default. To modify the value, you must set it from the command line using the Read Ahead option. The default normal option satisfies the performance requirements for a typical volume. The disabled value implies no read ahead. The most efficient value for the controllers depends on your application. Aggressive read ahead is optimal for sequential access but it degrades random access.

BIOS CONFIGURATION

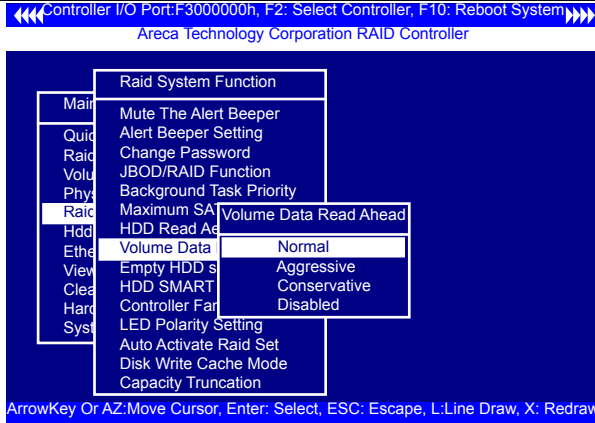

3.7.5.9 Empty HDD slot LED

The firmware has added the "Empty HDD Slot LED" option to setup the fault LED light "ON" or "OFF" when there is no HDD installed on this slot. When each slot has a power LED for the HDD installed identify, user can set this option to "OFF". Choose option "ON", the RAID controller will light the fault LED; if no HDD installed.

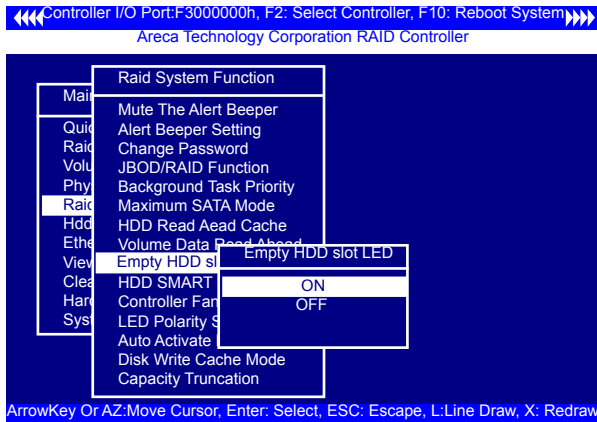

BIOS CONFIGURATION

3.7.5.10 HDD SMART Status Polling

An external RAID enclosure has the hardware monitor in the dedicated backplane that can report HDD temperature status to the controller. However, PCI cards do not use backplanes if the drives are internal to the main server chassis. The type of enclosure cannot report the HDD temperature to the controller. For this reason, "HDD SMART Status Polling" was added to enable scanning of the HDD temperature function. It is necessary to enable "HDD SMART Status Polling" function before SMART information is accessible. This function is disabled by default.

The above screen shot shows how to change the McBIOS RAID manager setting to enable the polling function.

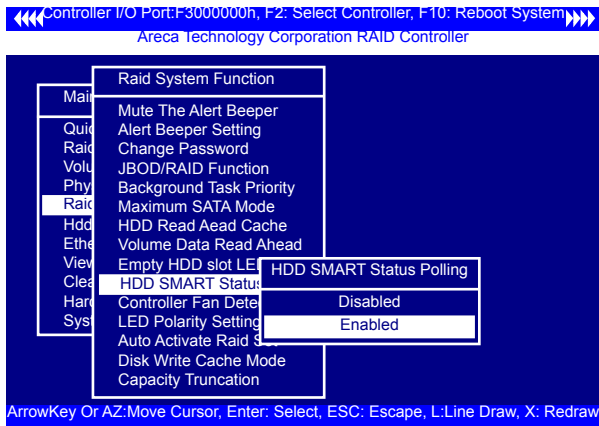

3.7.5.11 Controller Fan Detection

Included in the product box is a field replaceable passive heatsink to be used only if there is enough airflow to adequately cool the passive heatsink.

The "Controller Fan Detection" function is available in the version 1.36 date: 2005-05-19 and later for preventing the Buzzer warning. When using the passive heatsink, disable the "Controller Fan Detection" function through this McBIOS RAID manager setting.

BIOS CONFIGURATION

The following screen shot shows how to change the McBIOS RAID manager setting to disable the beeper function. **(This function is not available in the web browser setting.)**

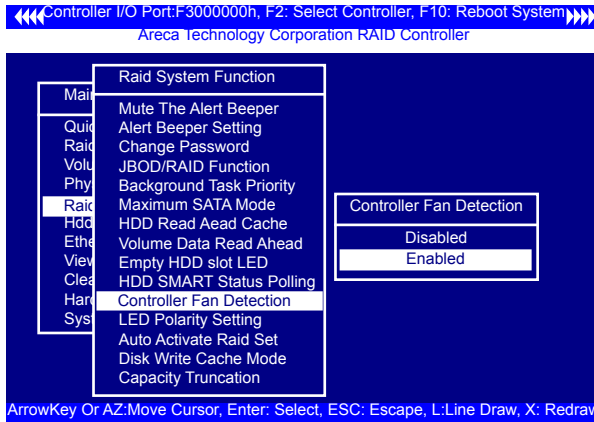

3.7.5.12 LED Polarity Setting

This function is used to set the polarity of individual fault/activity headers for the LED.

Polarity of individual fault/activity headers uses Areca Intelligent Electronics: Auto

Polarity of individual fault/activity headers set to Low: Active Low

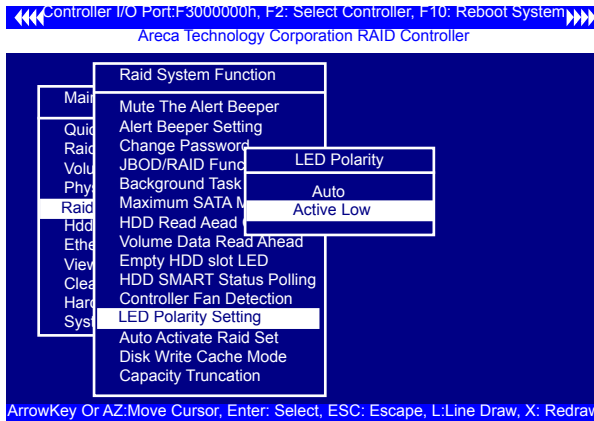

BIOS CONFIGURATION

3.7.5.13 Auto Activate Raid Set

When some of the disk drives are removed in power off state or boot up stage, the RAID set state will change to "Incomplete State". But if a user wants to automatically continue to work while the SAS RAID controller is powered on, then user can set the "Auto Activate Raid Set" option to "Enabled". The RAID state will change to "Degraded Mode" while it powers on.

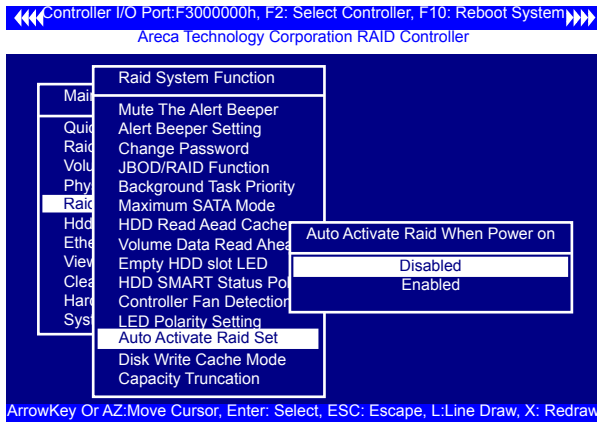

3.7.5.14 Disk Write Cache Mode

User can set the "Disk Write Cache Mode" to Auto, Enabled, or Disabled. "Enabled" increases speed, "Disabled" increases reliability.

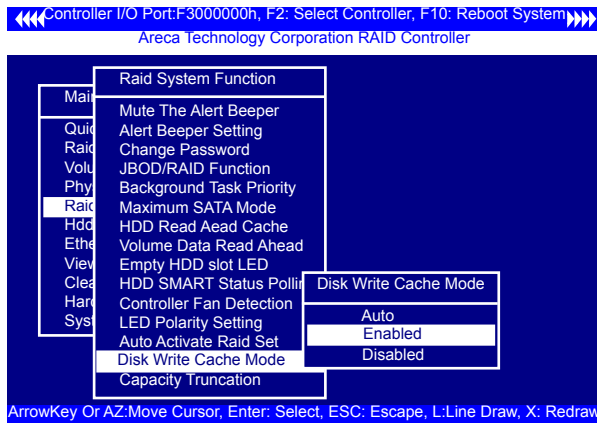

BIOS CONFIGURATION

3.7.5.15 Capacity Truncation

SATA RAID controller use drive truncation so that drives from differing vendors are more likely to be able to be used as spares for each other. Drive truncation slightly decreases the usable capacity of a drive that is used in redundant units.

The controller provides three truncation modes in the system configuration: "Multiples Of 10G", "Multiples Of 1G", and "No Truncation".

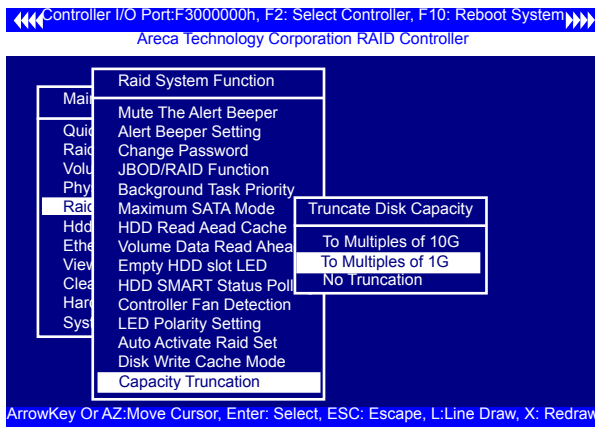

Multiples Of 10G: If you have 120 GB drives from different vendors; chances are that the capacity varies slightly. For example, one drive might be 123.5 GB, and the other 120 GB. "Multiples Of 10G" truncates the number under tens. This makes the same capacity for both of these drives so that one could replace the other.

Multiples Of 1G: If you have 123 GB drives from different vendors; chances are that the capacity varies slightly. For example, one drive might be 123.5 GB, and the other 123.4 GB. "Multiples Of 1G" truncates the fractional part. This makes the same capacity for both of these drives so that one could replace the other.

No Truncation: It does not truncate the capacity.

BIOS CONFIGURATION

3.7.6 HDD Power Management

Areca has automated the ability to manage HDD power based on usage patterns. The "HDD Power Management" allows you to choose a "Stagger Power On Control", "Low Power Idle", "Low RPM" and completely "Spins Down Idle HDD". It is designed to reduce power consumption and heat generation on idle drives.

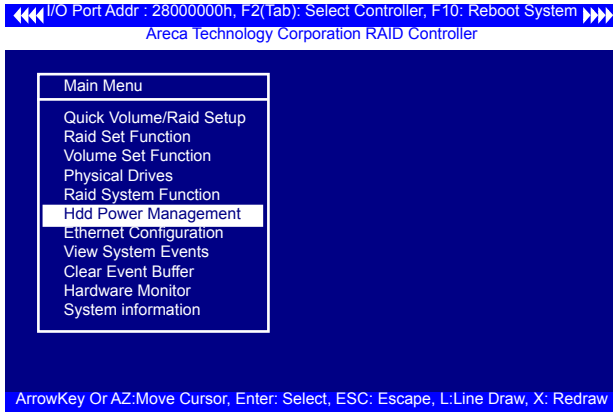

3.7.6.1 Stagger Power On

In a PC system with only one or two drives, the power can supply enough power to spin up both drives simultaneously. But in systems with more than two drives, the startup current from spinning up the drives all at once can overload the power supply, causing damage to the power supply, disk drives and other system components. This damage can be avoided by allowing the host to stagger the spin-up of the drives. The SAS/SATA drives have support stagger spin-up capabilities to boost reliability. Stagger spin-up is a very useful feature for managing multiple disk drives in a storage subsystem. It gives the host the ability to spin up the disk drives sequentially or in groups, allowing the drives to come ready at the optimum time without straining the system power supply. Staggering drive spin-up in a multiple drive environment also avoids the extra cost of a power supply designed to meet short-term startup power demand as well as steady state conditions.

BIOS CONFIGURATION

Areca RAID controller has included the option for customer to select the disk drives sequentially stagger power up value. The values can be selected from 0.4s to 6s per step which powers up one drive.

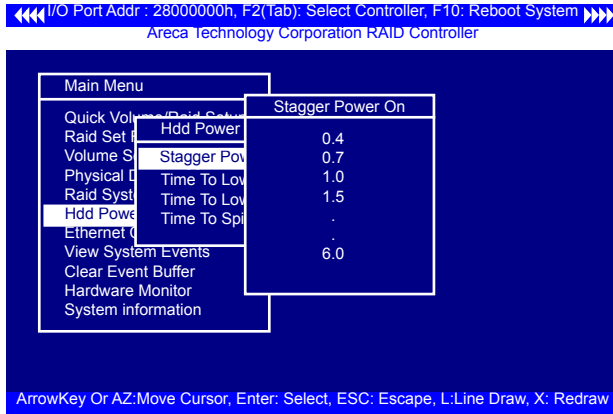

3.7.6.2 Time to Hdd Low Power Idle

This option delivers lower power consumption by automatically unloading recording heads during the setting idle time.

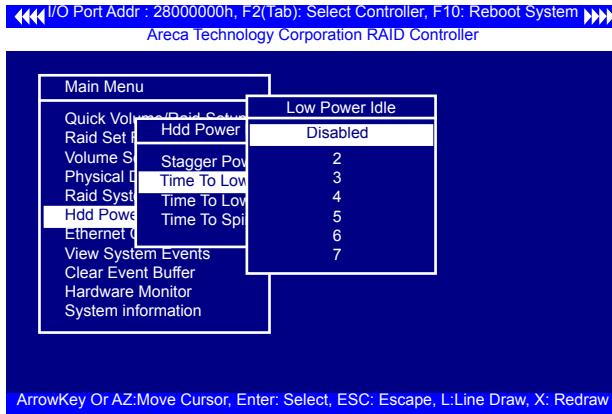

BIOS CONFIGURATION

3.7.6.3 Time To Low RPM Mode

This function can automatically spin disks at lower RPM if there have not been used during the setting idle time.

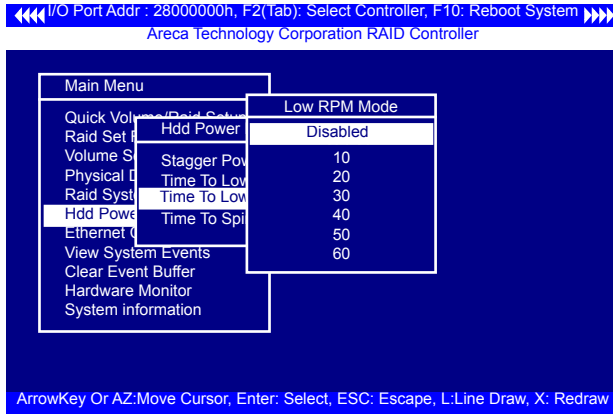

3.6.6.4 Time To Spin Down Idle Hdd

This function can automatically spin down the drive if it hasn't been accessed for a certain amount of time. This value is used by the drive to determine how long to wait (with no disk activity, before turning off the spindle motor to save power.)

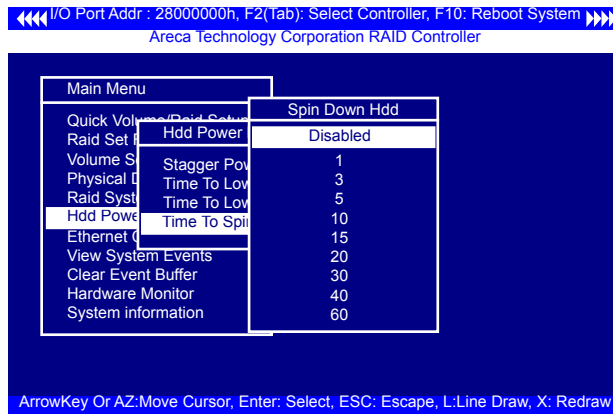

BIOS CONFIGURATION

3.7.7 Ethernet Configuration (Ethernet Port Support)

Use this feature to set the controller Ethernet port configuration. It is not necessary to create reserved disk space on any hard disk for the Ethernet port and HTTP service to function; these functions are built into the controller firmware. To choose the "Ethernet Configuration" of the controller, move the cursor bar to the main menu "Ethernet Configuration" function item and then press the **Enter** key.

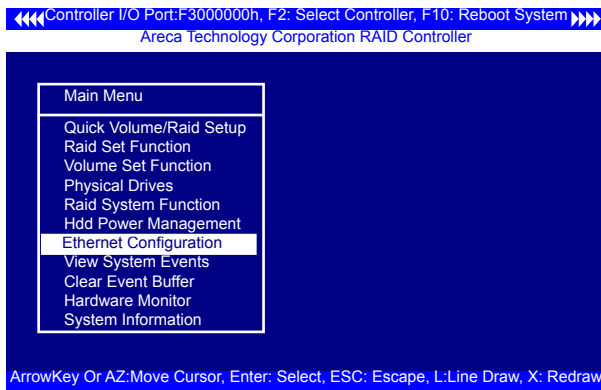

3.7.7.1 DHCP Function

DHCP (Dynamic Host Configuration Protocol) allows network administrators centrally manage and automate the assignment of IP (Internet Protocol) addresses on a computer network. When using the TCP/IP protocol (Internet protocol), it is necessary for a computer to have a unique IP address in order to communicate to other computer systems. Without DHCP, the IP address must be entered manually at each computer system. DHCP lets a network administrator supervise and distribute IP addresses from a central point. The purpose of DHCP is to provide the automatic (dynamic) allocation of IP client configurations for a specific time period (called a lease period) and to minimize the work necessary to administer a large IP network. To configure the DHCP function of the controller, move the cursor bar to "DHCP Function" item, then press **Enter** key to show the DHCP setting. Select the "Disabled" or "Enabled" option to enable or

BIOS CONFIGURATION

disable the DHCP function. If DHCP is disabled, it will be necessary to manually enter a static IP address that does not conflict with other devices on the network.

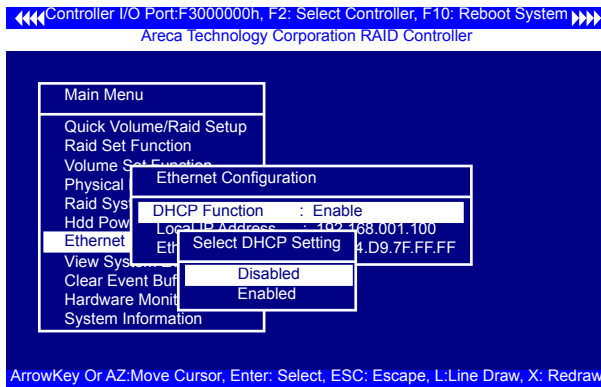

3.7.7.2 Local IP address

If you intend to set up your client computers manually (no DHCP), make sure that the assigned IP address is in the same range as the default router address and that it is unique to your private network. However, it is highly recommend to use DHCP if that option is available on your network. An IP address allocation scheme will reduce the time it takes to set-up client computers and eliminate the possibilities of administrative errors and duplicate addresses. To manually configure the local IP address of the controller, move the cursor bar to "Local IP address" item, then press the **Enter** key to show the default address setting in the SATA RAID controller. You can then reassign the static IP address of the controller.

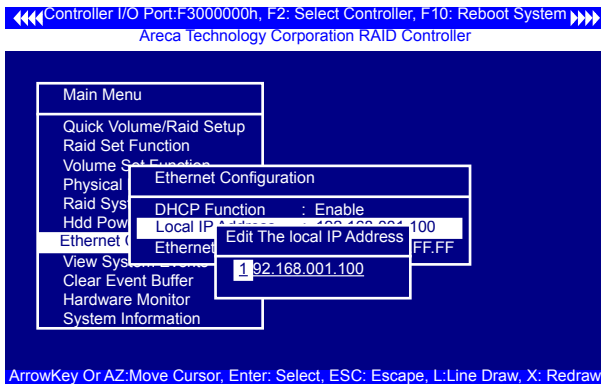

BIOS CONFIGURATION

3.7.7.3 Ethernet Address

A MAC address stands for “Media Access Control” address and is unique to every single Ethernet device. On an Ethernet LAN, it’s the same as your Ethernet address. When you’re connected to a local network from the SATA RAID controller Ethernet port, a correspondence table relates your IP address to the SATA RAID controller’s physical (MAC) address on the LAN.

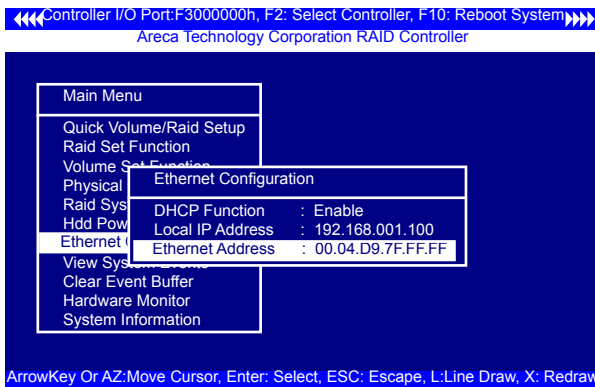

3.7.8 View System Events

To view the SATA RAID controller’s system events information, move the cursor bar to the main menu and select the “View System Events” link, then press the **Enter** key. The SATA RAID controller’s events screen will appear.

Choose this option to view the system events information: Timer, Device, Event type, Elapsed Time, and Errors. The RAID system does not have a real time clock. The time information is the relative time from the SATA RAID controller powered on.

BIOS CONFIGURATION

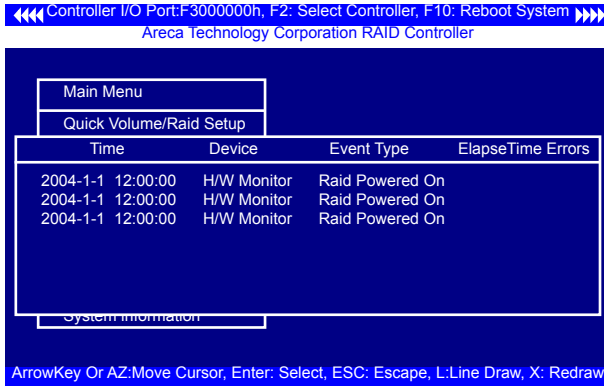

3.7.9 Clear Events Buffer

Use this feature to clear the entire events buffer.

3.7.10 Hardware Monitor

To view the RAID controller's hardware monitor information, move the cursor bar to the main menu and click the "Hardware Monitor" link. The hardware information screen appears.

The "The Hardware Monitor" provides the temperature and fan speed (I/O Processor fan) of the SATA RAID controller.

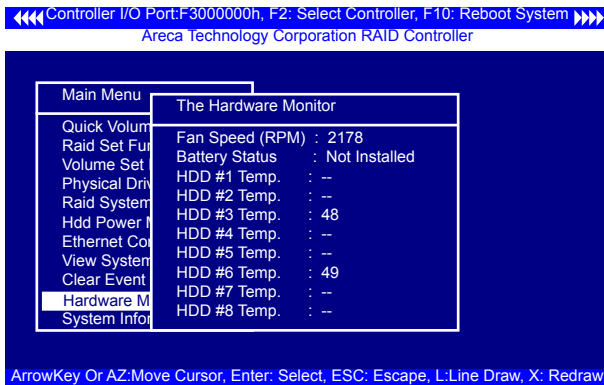

BIOS CONFIGURATION

3.7.11 System Information

Choose this option to display main processor, CPU instruction Cache and data cache size, firmware version, serial number, system memory/speed and controller model name. To check the system information, move the cursor bar to "System Information" item, then press **Enter** key. All relevant controller information will be displayed.

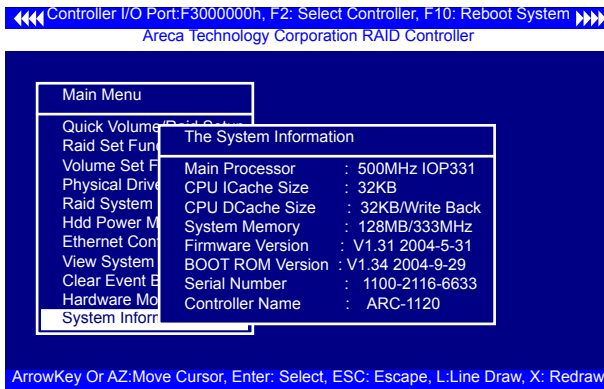

4. Driver Installation

This chapter describes how to install the SATA RAID controller driver to your operating system. The installation procedures use the following terminology:

Installing operating system on the SATA volume

If you have a new drive configuration without an operating system and want to install operating system on a disk drive managed by the SATA RAID Controller. The driver installation is a part of the operating system installation.

Installing SATA RAID controller into an existing operating system

The computer has an existing operating system installed and the SATA RAID controller is being installed as a secondary controller.

Have all required system hardware and software components on hand before proceeding with the setup and installation.

Materials required:

- Microsoft Windows 2000/XP/2003, Linux, FreeBSD or more installation CD
- SATA RAID Controller Device Drivers Software CD
- SATA RAID controller

4.1 Creating the Driver Diskettes

The software CD disc shipped with the SATA RAID controller is a self booting CD. In order to create driver diskettes for Windows, Linux, FreeBSD or more installation drivers, your system is required to support booting from the CD-ROM.

If you do not have the software CD disc with the package, contact your local dealer or you can also download the latest version drivers for Windows 2000/XP/2003/Vista, Linux, FreeBSD and more from the Areca web site at <http://www.areca.com.tw>

DRIVER INSTALLATION

These driver diskettes are intended for use with new operating system installations. Determine the correct kernel version and identify which diskette images contain drivers for that kernel. If the driver file ends in .img, create the appropriate driver diskette using "dd" utility. The following steps are required to create the driver diskettes:

1. The computer system BIOS must be set to boot-up from the CD-ROM.
2. Insert the SATA Controller Driver software CD disc into the CD-ROM drive.
3. The system will boot-up from CD-ROM Drive.

Note:

It will take about 5 minutes to boot up the Knoppix GNU/Linux, Live Linux CD.

4. To create the driver diskette, for example: making the CentOS 5 driver diskette.
 - 4a. Execute xterm by clicking the XTerm icon on left-bottom toolbar.
 - 4b. Change the path to the specific driver image.
`cd /cdrom/PACKAGES/Linux/DRIVER/CentOS_5`
 - 4c. Dump the driver image into floppy diskette using "dd" utility, Command format: `dd if=<image file> of=<destination>`
`dd if=driver.img of=/dev/fd0`
 - 4d. When the operation is complete, the following messages are shown.
2880+0 records in
2880+0 records out
1474560 bytes (1.5 MB) copied, 97.5903 seconds, 15.1 kB/s

The driver diskette is made now. Proceed to the following instruction for installation procedures.

4.2 Driver Installation for Windows

The SATA RAID controller can be used with Microsoft Windows 2000, Windows XP, Windows Server 2003, and Vista. The SATA RAID controllers support SCSI Miniport and StorPort device driver for Windows Server 2003/Vista.

4.2.1 New Storage Device Drivers in Windows 2003/XP-64/Vista

The Storport driver is new to Windows 2003/XP-64/Vista. Storport implements a new architecture designed for better performance with RAID systems and in Storage Area Network (SAN) environments. Storport delivers higher I/O throughput, enhanced manageability, and an improved miniport interface. Storport better utilizes faster adapters through the use of reduced Delay Procedure Call (DPC) and improved queue management.

4.2.2 Install Windows 2000/XP/2003/Vista on a SATA RAID Volume

The following instructions explain how to install the SATA RAID controller driver. For completed details on installing Windows, see the Windows User's Manual.

4.2.2.1 Installation Procedures

The following detailed procedure installing the SATA RAID controller driver while installing Windows 2000/XP/2003/Vista. Have your bootable Microsoft Windows 2000/XP/2003/Vista CD and follow the required procedure below to install SATA RAID controller:

1. Make sure you follow the instructions in Chapter 2 "Hardware Installation" to install the controller and connect the disk drives or enclosure.
2. Start the system and then press **Tab+F6** to access the McBIOS RAID manager. Use the McBIOS RAID manager to create the RAID set and volume set to which you will install Windows.

DRIVER INSTALLATION

For details, see Chapter 3 “McBIOS RAID manager”. Once a volume set is created and configured, continue with next step to install the operating system.

3. Insert the Windows setup CD and reboot the system to begin the Windows installation.

Note:

The computer system BIOS must support bootable from CD-ROM.

4. Press **F6** key as soon as the Windows screen shows “Setup is Inspecting your Computer’s Hardware Configuration”. A message stating “Press F6 to Specify Thrid-party RAID Controller” will display during this time. This must be done or else the Windows installer will not prompt for the driver for from the SATA RAID controller and the driver diskette will not be recognized.

5. The next screen will show: “Setup could not determine the type of one or more mass storage device installed in your system”. Selected “specify additional SCSI adapter” by pressing **S**.

6. Window will prompt to place the “Manufacturer-supplied hardware support disk” into floppy drive A: Insert the SATA RAID series driver diskette in drive “A:” and press **Enter** key.

7. Window will check the floppy; select the correct card and CPU type for your hardware from the listing and press **Enter** key to install it.

8. After Windows scans the hardware and finds the controller, it will display:

“Setup will load support for the following Mass Storage devices:”
“ARECA [Windows X86-64 Storport] SATA/SAS PCI RAID Controller (RAID6-Engine inside)”. Press **Enter** key to continue and copy the driver files. From this point on, simply follow the Microsoft Windows installation procedure. Follow the on-screen instructions, responding as needed, to complete the installation.

DRIVER INSTALLATION

9. After the installation is completed, reboot the system to load the new drivers/operating system.
10. See Chapter 5 in this manual to customize your RAID volume sets using McRAID storage manager.

4.2.2.2 Making Volume Sets Available to Windows System

When you reboot the system, log in as a system administrator. Continue with the following steps to make any additional volume sets or pass-through disks accessible to Windows. This procedure assumes that the SATA RAID controller hardware, driver, and Windows are installed and operational in your system.

1. Partition and format the new volume set or disks using Disk Administrator:
 - a. Choose "Administrative Tools" from the "Start" menu.
 - b. Choose "Computer Management" from the "Administrative Tools" menu.
 - c. Select "Storage".
 - d. Select "Disk Management".
2. Follow the on-screen prompts to write a signature to the drive.
3. Right click on the disk drive and select "Create Volume" from the menu.
4. Follow the on-screen prompts to create a volume set and to give a disk drive letter.

4.2.3 Installing Controller into an Existing Windows 2000/XP/2003/Vista Installation

In this scenario, you are installing the controller in an existing Windows system. To install the driver:

1. Follow the instructions in Chapter 2, the Hardware Installation Chapter, to install the controller and connect the disk drives or enclosure.

DRIVER INSTALLATION

2. Start the system and then press **Tab+F6** to enter the McBI-OS RAID manager utility. Use the configuration utility to create the raid set and volume set. For details, see Chapter 3, McBIOS RAID Manager. Once a volume set is created and configured, continue with installation of the driver.
3. Re-Boot Windows and the OS will recognize the SATA RAID Controller and launch the "Found New Hardware Wizard", which guides you in installing the SATA RAID driver.
4. The "Upgrade Device Driver Wizard" will pop-up and provide a choice of how to proceed. Choose "Display a list of known drivers for this device, so that you can choose a specific driver." and click on "Next".
5. When the next screen queries the user about utilizing the currently installed driver, click on the "Have Disk" button.
6. When the "Install From Disk" dialog appears, insert the SATA RAID controller driver diskette or the shipping CD-ROM and type-in or browse to the correct path for the "Copy manufacturer's files from:" dialog box.
7. After specifying the driver location, the previous dialog box will appear showing the selected driver to be installed. Click the "Next" button.
8. The "Digital Signature Not Found" screen will appear. Click on "Yes" to continue the installation.
9. Windows automatically copies the appropriate driver files and rebuilds its driver database.
10. The "Found New Hardware Wizard" summary screen appears; click the "Finish" button.
11. The "System Settings Change" dialog box appears. Remove the diskette from the drive and click **Yes** option to restart the computer to load the new drivers.
12. See Chapter 5 in this manual for information on customizing your RAID volumes using McRAID storage manager.

DRIVER INSTALLATION

4.2.3.1 Making Volume Sets Available to Windows System

When you reboot the system, log in as a system administrator. The following steps show how to make any new disk arrays or independent disks accessible to Windows 2000/XP/2003/Vista. This procedure assumes that the SATA RAID controller hardware, driver, and Windows are installed and operational in your system.

1. Partition and format the new arrays or disks using Disk Administrator:
 - a. Choose "Administrative Tools" from the "Start" menu.
 - b. Choose "Computer Management" from the "Administrative Tools" menu.
 - c. Select "Storage".
 - d. Select "Disk Management".
2. Follow the on-screen prompts to write a signature to the drive.
3. Right click on the drive and select "Create Volume" from the menu.
4. Follow the on-screen prompts to create a volume set and to assign a disk drive letter.

4.2.4 Uninstall controller from Windows 2000/XP/2003/Vista

To remove the SATA RAID controller driver from the Windows system, follow the instructions below.

1. Ensure that you have closed all applications and are logged in with administrative rights.
2. Open "Control Panel" and start the "Add/Remove Program" icon and uninstall and software for the SATA RAID controller.

DRIVER INSTALLATION

3. Go to "Control Panel" and select "System". Select the "Hardware" tab and then click the "Device Manager" button. In "Device Manager", expand the "SCSI and RAID Controllers" section. Right click on the "Areca SATA RAID Adapter" and select "uninstall".

4. Click "Yes" to confirm removing the SATA RAID driver. The prompt to restart the system will then be displayed.

4.3 Driver Installation for Linux

This chapter describes how to install the SATA RAID controller driver to Red Hat Linux, and SuSE Linux. Before installing the SATA RAID driver to the Linux, complete the following actions:

1. Install and configure the controller and hard disk drives according to the instructions in Chapter 2 Hardware Installation.

2. Start the system and then press **Tab+F6** to enter the McBIOS RAID manager configuration utility. Use the McBIOS RAID manager utility to create the RAID set and volume set. For details, see Chapter 3, McBIOS RAID Manager.

If you are using a Linux distribution for which there is not a compiled driver available from Areca, you can copy the source from the SATA software CD or download the source from the Areca website and compile a new driver.

Compiled and tested drivers for Red Hat and SuSE Linux are included on the shipped CD. You can download updated versions of compiled and tested drivers for Red Hat or SuSE Linux from the Areca web site at <http://www.areca.com.tw>. Included in these downloads is the Linux driver source, which can be used to compile the updated version driver for RedHat, SuSE and other versions of Linux.

Please refer to the "readme.txt" file on the included Areca software CD or website to make driver diskette and to install driver to the system.

DRIVER INSTALLATION

4.4 Driver Installation for FreeBSD

This chapter describes how to install the SATA RAID controller driver to FreeBSD. Before installing the SATA RAID driver to FreeBSD, complete following actions:

1. Install and configure the controller and hard disk drives according to the instructions in Chapter 2, Hardware Installation.
2. Start the system and then press **Tab+F6** to enter the McBIOS RAID Manager configuration utility. Use the McBIOS RAID manager utility to create the raid set and volume set. For details, see Chapter 3, McBIOS RAID Manager.

The supplied software CD that came with the SATA RAID controller includes compiled and tested drivers for FreeBSD 4.x (4.2 and onwards) and 5.x (5.2 and onwards). To check if a more current version driver is available, please see the Areca web site at <http://www.areca.com.tw>.

Please refer to the "readme.txt" file on the SATA RAID controller software CD or website to make driver diskette and to install driver to the system.

4.5 Driver Installation for Solaris 10

Please refer to the "readme.txt" file on the software CD or a manual from website: <http://www.areca.com.tw>

4.6 Driver Installation for Mac X

After hardware installation, the SATA disk drives connected to the SATA RAID Adapter must be configured and the volume set units initialized by the controller before they are ready to use by the system.

4.6.1 Installation Procedures

You must have administrative level permissions to install Areca Mac driver & software. You can install driver& software on your

DRIVER INSTALLATION

Power Mac G5 or Mac Pro as below:

1. Insert the Areca Mac Driver & Software CD that came with your Areca SAS RAID controller.
2. Double-click on the following file that resides at <CD-ROM>\packages\MacOS to add the installer on the Finder.
 - a). install_mraid_mac.zip (For Power Mac G5)
 - b). install_mraid_macpro.zip (For Mac Pro)
3. Launch the installer by double-clicking the install_mraid_mac or install_mraid_macpro on the Finder.
4. Follow the installer steps to install Areca driver, MRAID (archttp64 and arc_cli utility) at the same time.
5. Reboot your Power Mac G5 or Mac Pro system.



6. See chapter 5 in this manual for information on customizing your RAID volumes using McRAID storage manager.

Normally archttp64 and arc_cli are installed at the same time on Areca SATA RAID adapter. Once archttp64 and arc_cli have been installed, the background task automatically starts each time when you start your computer. There is one MRAID icon showing on your desktop. This icon is for you to start up the McRAID storage manager (by archttp64) and arc_cli utility. You can also only upgrade the driver, archttp64 or arc_cli individual item that resides at <CD-ROM>\packages\MacOS Arc-cli performs many tasks at the command line. You can download arc-cli manual from Areca website or software CD <CDROM>\DOCS directory.

DRIVER INSTALLATION

4.6.2 Making Volume Sets Available to Mac OS X

When you create a volume through McRAID storage manager, the Mac OS X recognizes that a new disk is avail, and displays a message asking what you next want to do. If the message does not show up, start the "Macintosh Disk Utility" manually from the "Finder", use the "Go" menu and open the "Utilities" folder. Double-click on the "Macintosh Disk Utility" program. Follow the on-screen prompts to create a volume set and to assign a disk drive letter.

4.7 Driver Installation for UnixWare 7.1.4

Please refer to the "readme.txt" file on the software CD or a manual from website: <http://www.areca.com.tw>

4.8 Driver Installation for NetWare 6.5

Please refer to the "readme.txt" file on the software CD or a manual from website: <http://www.areca.com>.

ARCHTTP PROXY SERVER INSTALLATION

5. ArcHttp Proxy Server Installation

Overview

After hardware installation, the SATA disk drives connected to the SATA RAID controller must be configured and the volume set units initialized before they are ready to use.

The user interface for these tasks can be accessed through the built-in configuration that resides in the controller's firmware. It provides complete control and management of the controller and disk arrays, eliminating the need for additional hardware or software.

In addition, a software utility to configure the SATA RAID is provided on the CD delivered with SATA controller. This software CD contains the software utility that can monitor, test, and support the SATA RAID controller. The software utility and McRAID storage manager can configure and monitor the SATA RAID controller via ArchHttp proxy server. The following table outlines their functions:

Configuration Utility	Operating System Supported
McBIOS RAID Manager	OS-Independent
McRAID Storage Manager (Via Archhttp proxy server)	Windows 2000/XP/2003, Linux, FreeBSD, Solaris and Mac
SAP Monitor (Single Admin portal to scan for multiple RAID units in the network, Via ArchHttp Proxy Server)	Windows 2000/XP/2003

From version 1.6 and later, the HTTP management software (ArcHttp) runs as a service or daemon, and have it automatically start the proxy for all controllers found. This way the controller can be managed remotely without having to sign in the server. The HTTP management software (ArcHttp) also has integrated the General Configuration, Mail Configuration and SNMP Configuration. Those can be configured in local or remote standard web browser.

Note:

If your controller have onboard LAN port, you do not need to install ArcHttp proxy server, you can use McRAID storage manager directly.

ARCHTTP PROXY SERVER INSTALLATION

5.1 For Windows

You must have administrative level permissions to install SATA RAID software. This procedure assumes that the SATA RAID hardware and Windows are installed and operational in your system. Screen captures in this section are taken from a Windows XP installation. If you are running another version of Windows, your installation screen may look different, but the ArchHttp proxy server installation is essentially the same.

1. Insert the RAID controller software CD in the CD-ROM drive.
2. Run the setup.exe file that resides at: <CD-ROM>\PACKAGES\Windows\http\setup.exe on the CD-ROM.
3. The screen shows "Preparing to Install".



Follow the on-screen prompts to complete ArchHttp proxy server software installation.

A program bar appears that measures the progress of the ArchHttp setup. When this screen complete, you have completed the ArchHttp proxy server software setup.

4. After a successful installation, the "Setup Complete" dialog box is displayed.



Click the "Finish" button to complete the installation.

ARCHTTP PROXY SERVER INSTALLATION

Click on the "Start" button in the Windows task bar and then click "Program", select the "McRAID" and run " ArchHttp proxy server". The ArchHttp proxy server dialog box appears.

1. When you select "Controller#01(PCI)" then click "Start" button. Then web browser McRAID storage manager appears.
2. If you select "Cfg Assistant" then click "Start" button. The "ArchHttp Configuration" appears. (Please refer to section 5.6 ArchHttp Configuration)

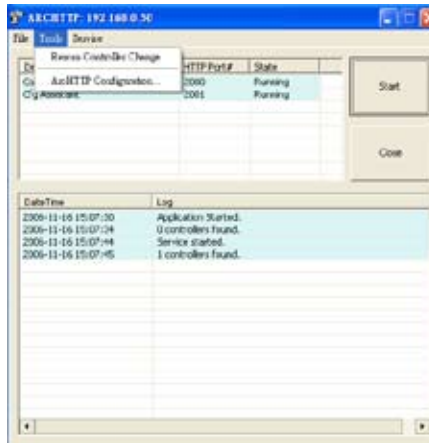

5.2 For Linux

You should have administrative level permissions to install SATA RAID software. This procedure assumes that the SATA RAID hardware and Linux are installed and operational in your system. The following details the Linux installation procedure of the SATA RAID controller software.

The ArchHttp proxy server is provided on the software CD delivered with SATA card or download from the www.areca.com.tw. The firmware embedded McRAID storage manager can configure and monitor the SATA RAID controller via ArchHttp Proxy Server.

1. Login as root. Copy the ArchHttp file to a local directory.
 - (1). Insert the SATA RAID controller CD in the CD-ROM drive.

ARCHTTP PROXY SERVER INSTALLATION

(2). Copy <CD-ROM>\PACKAGES\Mac\http directory to local (Ex:/usr/local/sbin).

Or

(1). Download from the www.areca.com.tw or from the email attachment.

2. You must have administrative level permissions to install SATA RAID controller ArchHttp proxy server software. This procedure assumes that the SATA RAID hardware and driver are installed and operational in your system.

The following details are the installation procedure of the SATA RAID controller for Linux ArchHttp proxy server software.

(1).Run the Archhttp proxy server by using the following command:

Usage: ./archhttp32 (TCP_PORT) or ./archhttp64 (TCP_PORT). It depends on your OS version.

Parameters: TCP_PORT value= 1~65535 (If TCP_PORT assigned, Archhttp will start from this port. Otherwise, it will use the setting in the archhttpsrv.conf or default 81). This is the port address assigning for the first adapter.

Such as: archhttp64 1553

(2). Archhttp server console started, controller card detected then ArchHttp proxy server screen appears.

Copyright (c) 2004 Areca, Inc. All Rights Reserved.
Areca HTTP proxy server V1.80.240 for Areca RAID controllers.

Controller(s) list

Controller[1](PCI) : Listen to port[1553].
Cfg Assistant : Listen to port[1554].
Binding IP:[0.0.0.0]
Note: IP[0.0.0.0] stands for any ip bound to this host.

Press CTRL-C to exit program!!

Controller [1] Http: New client [9] accepted

ARCHTTP PROXY SERVER INSTALLATION

Controller [1] Http: New Recv 243 bytes
Controller [1] Http: Send [174] bytes back to the client

(3). If you need the "Cfg Assistant", please refer to section 5.6 ArchHttp Configuration.

(4). See the next chapter detailing the McRAID storage manager to customize your RAID volume set.

5.3 For FreeBSD

You should have administrative level permissions to install SATA RAID software. This procedure assumes that the SATA RAID hardware and FreeBSD are installed and operational in your system. The following details FreeBSD installation procedure of the SATA RAID controller software.

1. Insert the RAID controller CD in the CD-ROM drive.
2. Copy <CD-ROM>\PACKAGES\FreeBSD\http directory to local
The next following step is the same with Linux. Please see section 5.2 For Linux.

5.4 For Solaris 10 x86

You must have administrative level permissions to install SATA RAID software. This procedure assumes that the SATA RAID hardware and FreeBSD are installed and operational in your system. The following details Solaris installation procedure of the SATA RAID controller software.

1. Insert the RAID subsystem CD in the CD-ROM drive.
2. Copy <CD-ROM>\PACKAGES\Solaris\http directory to local
The next following step is the same with Linux. Please see section 5.2 For Linux.

5.5 For Mac OS 10.x

The ArchHttp proxy server is provided on the software CD delivered with SATA card or download from the www.areca.com.tw. The

ARCHTTP PROXY SERVER INSTALLATION

firmware embedded McRAID storage manager can configure and monitor the SATA RAID controller via ArchHttp proxy server. The Archhttp proxy server for Mac, please reference Chapter 4.6 Driver Installation for Mac 10.x or refer to the the Mac_manual_xxxx.pdf that resides at CD <CD-ROM>\DOCS directory. You can install driver, archttp64 and arc-cli from software CD < CD >\package\ Mac OS directory at the same time.

5.6 ArchHttp Configuration

The ArchHttp proxy server will automatically assign one additional port for setup its configuration. If you want to change the "archttp-srv.conf" setting up of ArchHttp configuration, For example: General Configuration, Mail Configuration, and SNMP Configuration, please start web browser by entering http://[computer IP address]:[cfg port number]

ARCHTTP Configurations

General Configuration
Mail Configuration
SNMP Trap Configuration

General Configuration

Binding IP	0.0.0.0
HTTP Port#	8080
Display HTTP Connection Information To Console	<input checked="" type="checkbox"/>
Scanning PCI Device	<input checked="" type="radio"/> Yes <input type="radio"/> No
Scanning RS-232 Device	<input type="radio"/> Yes <input checked="" type="radio"/> No
Scanning Inband Device	<input type="radio"/> Yes <input checked="" type="radio"/> No

Confirm The Operation

Submit Reset

The ArchHttp configuration starts.

- **General Configuration**

Binding IP 0.0.0.0: You can choose either local administration or remote administration to connect web browser.

Binding IP 127.0.0.1: Using local administration to connect web browser.

Binding IP 192.168.0.44: Using remote administration to connect web browser.

HTTP Port#: Value 1~65535

Display HTTP Connection Information To Console: Select **Yes** to show Http send bytes and receive bytes information in the console.

ARCHTTP PROXY SERVER INSTALLATION

Scanning PCI Device: Select "Yes" for ARC-1XXX series adapter
Scanning RS-232 Device: No
Scanning Inband Device: No

● Mail Configuration

When you open the mail configuration page, you will see following settings:

SMTP server IP Address: Enter the SMTP server IP address which is not McRAID storage manager IP. Ex: 192.168.0.2

Sender Name: Enter the sender name that will be shown in the outgoing mail. Ex: RaidController_1

Mail address: Enter the sender email that will be shown in the outgoing mail, but don't type IP to replace domain name.
Ex: RaidController_1@areca.com.tw

Account: Enter the valid account if your SMTP mail server need authentication.

Password: Enter the valid password if your SMTP mail server need authentication.

The screenshot displays the 'ARCHTTP Configurations' web interface. On the left, there is a navigation menu with links for 'General Configuration', 'Mail Configuration', and 'BMC Diagnostic Configuration'. The main content area is titled 'ARCHTTP Configurations' and contains several configuration sections:

- SMTP Server Configuration:** Includes a text input field for 'SMTP Server IP Address'.
- Mail Address Configuration:** Contains a table with four rows for 'MailTo Name' and 'Mail Address', and another table with two rows for 'Account' and 'Password'.
- Event Notification Configuration:** Features a list of notification options with radio buttons, such as 'Enable Error Notification', 'Disable Error Notification', 'Send Email', 'Send SMS', 'Send Page and Email', 'Send Page, Email and SMS', 'Send All Error', 'No Error Notification Will Be Sent', 'Send Only Urgent Event', 'Send Urgent and Error Event', 'Send Urgent, Error and Warning Event', and 'Send All Error'. There are also checkboxes for 'Notification For Its Event' and 'Notify the 24 Hours'.

At the bottom of the configuration area, there are 'Submit' and 'Reset' buttons.

ARCHTTP PROXY SERVER INSTALLATION

MailTo Name: Enter the alert receiver name that will be shown in the outgoing mail.

Mail Address: Enter the alert receiver mail address.

Ex: admin@areca.com.tw

Note:

Please make sure you have completed mail address before you submit mail configurations.

• SNMP Trap Configuration

Please refer to the 6.8.4 SNMP configuration(12/16/24-port) section.

Configure configuration and submit. After ArchHttp configurations have successfully submitted, the Archttp console restarts again.

The screenshot displays the 'ARCHTTP Configurations' web interface. On the left, there is a navigation menu with links for 'General Configurations', 'Mail Configurations', and 'SNMP Trap Configurations'. The main content area is titled 'SNMP Trap Configurations' and contains several sections:

- SNMP Trap Configurations:** A table with three rows for 'SNMP Trap IP Address #1', '#2', and '#3'. Each row has input fields for IP address and port, and a 'guard' checkbox. The first row has '192.168.0.1' and '170' entered, with 'guard' checked. The second and third rows have '0.0.0.0' and '0' entered, with 'guard' checked.
- SNMP System Configurations:** A section with a 'Community' input field containing the value 'public'.
- SNMP Trap Notification Configurations:** A section with two columns of radio button options:
 - Column 1: Disable Error Notifications, Digest Error Notifications, Secure Trap Notifications, Warning Error Notifications, Information Notifications.
 - Column 2: No Error Notifications Will Be Sent, Send Only Digest Events, Send Digest, Secure And Secure Digest, Send Digest, Secure And Warning Digest, Send All Events.

At the bottom of the form, there is a 'Confirm The Operation' checkbox and two buttons: 'Submit' and 'Cancel'.

Note:

Event Notification Table refer to Appendix D. After you confirm and submit configurations, you can use "Generate Test Event" feature to make sure these settings are correct.

WEB BROWSER-BASED CONFIGURATION

6. Web Browser-based Configuration

Before using the firmware-based browser McRAID storage manager utility, do the initial setup and installation of this product. If you need to boot up the operating system from a volume set, you must first create a RAID volume by using McBIOS RAID Manager. Please refer to section 3.3 Using Quick Volume /Raid Setup Configuration for information on creating this initial volume set.

The McRAID storage manager is firmware-based utility, which is accessible via the browser installed on your operating system. The web browser-based McRAID storage manager is a HTML-based application, which utilizes the browser (IE, Netscape and Mozilla etc) installed on your monitor station.

It can be accessed through the In-Band PCI-X/PCIe bus or Out-of-Band Ethernet port. The In-Band method via archhttp proxy server to launch the web browser-based McRAID storage manager. The firmware-embedded web browser-based McRAID storage manager allows local or remote to access it from any standard internet browser via a LAN or WAN with no software or patches required. The firmware contains SMTP manager monitors all system events and user can select either single or multiple user notifications to be sent via LAN with "Plain English" e-mails. The firmware-embedded SNMP agent allows remote to monitor events via LAN with no SNMP agent required.

- Create RAID set,
- Expand RAID set,
- Define volume set,
- Add physical drive ,
- Modify volume set,
- Modify RAID level/stripe size,
- Define pass-through Disk drives,
- Modify system function,
- Update firmware, and
- Designate drives as hot spares.

6.1 Start-up McRAID Storage Manager

With the McRAID storage manager, you can locally manage a system containing a SATA RAID controller that has Windows,

WEB BROWSER-BASED CONFIGURATION

Linux or more and a supported browser. A locally managed system requires all of the following components:

- A supported web browser, which should already be installed on the system.
- Install ArchHttp proxy server on the SATA RAID system. (Refer to Chapter 5, Archhttp Proxy Server Installation)
- Remote and managed systems must have a TCP/IP connection.

• Start-up McRAID Storage Manager from Windows Local Administration

Screen captures in this section are taken from a Windows XP installation. If you are running another version of Windows, your screens may look different, but the ArchHttp proxy server installation is essentially the same.

1. To start the McRAID storage manager for browser-based management, selecting "Controller#01(PCI)" and then click the "Start" button.

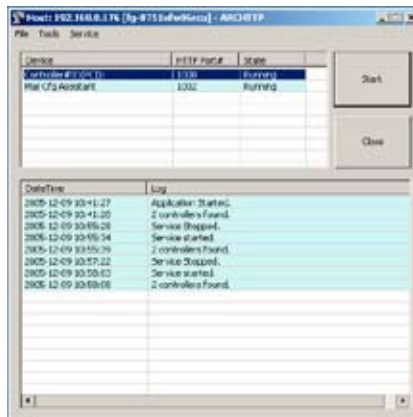

The "Enter Network Password" dialog screen appears, type the user name and password. The SATA RAID controller default user name is "**admin**" and the password is "**0000**". After entering the user name and password, press "Enter" to access the McRAID storage manager.

WEB BROWSER-BASED CONFIGURATION



• Start-up McRAID Storage Manager from Linux/ FreeBSD/Solaris/Mac Local Administration

To configure the SATA RAID controller. You need to know its IP address. You can find the IP address assigned by the Archhttp proxy server installation: Binding IP:[X.X.X.X] for[Computer IP Address] and controller listen to port for [Port Number].

(1). Launch your McRAID storage manager by entering `http://[Computer IP Address]:[Port Number]` in the web browser.

(2). When connection is established, the "System Login" screen appears. The SAS RAID controller default User Name is "admin" and the Password is "0000"

• Start-up McRAID Storage Manager Through Ethernet port (Out-of-Band)

Areca now offers an alternative means of communication for the PCIe RAID controller – Web browser-based McRAID storage manager program. User can access the built-in configuration without needing system starting up running the ArchHttp proxy sever. The web browser-based McRAID storage manager program is an HTML-based application, which utilizes the browser installed on your remote system.

To ensure proper communications between the PCIe RAID controller and web browser-based McRAID storage manager, Please connect the RAID controller LAN port to any LAN switch port.

The controller has embedded the TCP/IP & web browser-based RAID manager in the firmware. User can remote manage the RAID controller without adding any user specific software (platform independent) via standard web browsers directly connected to the 10/100 RJ45 LAN port.

WEB BROWSER-BASED CONFIGURATION

To configure RAID controller on a remote machine, you need to know its IP address. The IP address will default show in McBIOS RAID manager of "Ethernet Configuration" or "System Information" option. Launch your firmware-embedded TCP/IP & web browser-based McRAID storage manager by entering `http://[IP Address]` in the web browser.

Note:

You can find controller Ethernet port IP address in McBIOS RAID manager "System Information" option.

6.2 McRAID Storage Manager

The McRAID storage manager start-up configuration screen displays the current configuration of your SATA RAID controller. It displays the Raid Set List, Volume Set List, and Physical Disk List. The RAID set information, volume set information, and drive information can also be viewed by clicking on the "Raid Set Hierarchy" screen. The current configuration can also be viewed by clicking on "Raid Set Hierarchy" in the main menu.

The screenshot shows the McRAID Storage Manager web interface. On the left is a navigation menu with options: "Quick Function", "RaidSet Function", "VolumeSet Function", "Physical Drive", "System Controls", and "Information". The main content area features the "Areca Technology Corporation" logo and the "Raid Set Hierarchy" section. This section contains a table of RAID sets and a table of IDE channels.

Raid Set	IDE Channel	Volume Set/Chk/Lost	Volume State	Capacity
Raid Set #0	Chk1	ABC1110-2214010000	Normal	256 1GB
Raid Set #0	Chk2			
Raid Set #0	Chk3	ABC1110-2214010000	Normal	256 1GB
Raid Set #0	Chk4	ABC1110-2214010000	Normal	256 1GB

Channel	Usage	Capacity	Model
Chk1	Raid Set #0	256 1GB	WDC WD2000GD-11E000
Chk2	Raid Set #0	256 1GB	WDC WD2000GD-11E000
Chk3	Raid Set #0	256 1GB	WDC WD2000GD-22BB00
Chk4	N.A.	31.A.	31.A.
Chk5	Raid Set #0	256 1GB	WDC WD2000GD-22BB00
Chk6	N.A.	31.A.	31.A.
Chk7	N.A.	31.A.	31.A.
Chk8	N.A.	31.A.	31.A.

To display RAID set information, move the mouse cursor to the desired RAID set number, then click it. The RAID set information will display. To display volume set information, move the mouse cursor to the desired volume set number, then click it. The volume set information will display. To display drive information, move the mouse cursor to the desired physical drive number, then click it. The drive information will display.

WEB BROWSER-BASED CONFIGURATION

6.3 Main Menu

The main menu shows all available functions, accessible by clicking on the appropriate link.

Individual Category	Description
Quick Function	Create a default configuration, which is based on the number of physical disks installed; it can modify the volume set Capacity, Raid Level, and Stripe Size.
RaidSet Functions	Create a customized RAID set.
VolumeSet Functions	Create customized volume sets and modify the existed volume sets parameter.
Physical Drives	Create pass through disks and modify the existing pass through drives parameters. Also provides the function to identify disk drives (blinking Fault LED).
System Controls	Setting the raid system configuration.
Information	Viewing the controller information. The "RaidSet Hierarchy" can be viewed through the "RaidSet Hierarchy" item.

6.4 Quick Function

Quick Function
Quick Create
RaidSet Functions
VolumeSet Functions
Physical Drives
System Controls
Information

Areca Technology Corporation

Quick Create RAID Volume Set

Total Number Of Disks: 4
Select Raid Level: RAID 0
Minimum Capacity Allowed: 1000 GB
Select Capacity: 1000 GB
Create Two TB Volume Support: No
Volume Initialization Mode: Partitioned As Format Complete
Select Stripe Size: 128 Bytes

Confirm The operation
Submit Cancel

Note:

In Quick Create, your volume set is automatically configured based on the number of disks in your system. Use the "Raid Set Functions" and "Volume Set Functions" if you prefer to customize your system.

WEB BROWSER-BASED CONFIGURATION

The number of physical drives in the SATA RAID controller determines the RAID levels that can be implemented with the RAID set. You can create a RAID set associated with exactly one volume set. The user can change the RAID level, stripe size, and capacity. A hot spare option is also created depending upon the existing configuration.

Click the "Confirm The Operation" check box and click on the "Submit" button in the "Quick Create" screen, the RAID set and volume set will start to initialize.

Note:

If volume capacity exceeds 2TB, controller will show the "Greater Two TB Volume Support" sub-menu. Greater Two TB Volume Support option: No, 64bit LBA and For Windows.

For more details please download PDF file from **ftp://ftp.areca.com.tw/RaidCards/Documents/Manual_Spec/Over2TB_050721.zip**

6.5 RaidSet Functions

Use the "Raid Set Functions" and "Volume Set Functions" if you prefer to customize your system. Manual configuration can provide full control of the RAID set settings, but it will take longer to complete than the "Quick Volume/Raid Setup" configuration. Select the "Raid Set Functions" to manually configure the RAID set for the first time or delete and reconfigure existing RAID sets. (A RAID set is a group of disks containing one or more volume sets.)

6.5.1 Create Raid Set

To create a RAID set, click on the "Create Raid Set" link. A "Select The Drive For RAID Set" screen will be displayed showing the drive(s) connected to the current controller. Click on the selected physical drives within the current RAID set. The default RAID set name will always appear as "Raid Set. #".

Click the "Confirm The Operation" check box and click on the "Submit" button on the screen; the RAID set will start to initialize.

WEB BROWSER-BASED CONFIGURATION



6.5.2 Delete Raid Set

To delete a RAID set, click on the “Deleted Raid Set” link. The “Select The Raid Set To Delete” screen is displayed showing all existing RAID sets in the current controller. Click the RAID set number you which to delete in the select column on the delete screen. Click the “Confirm The Operation” check box and click on the “Submit” button in the screen to delete it.



6.5.3 Expand Raid Set

Instead of deleting a RAID set and recreating it with additional disk drives, the “Expand Raid Set” function allows the users to add disk drives to the RAID set that have already been created. To expand a RAID set:

Select the “Expand Raid Set” option. If there is an available disk, then the “Select SATA Drives For Raid Set Expansion” screen appears.

Select the target RAID set by clicking on the appropriate radio button. Select the target disk by clicking on the appropriate check box.

Press the **Yes** key to start the expansion on the RAID set.



The new additional capacity can be utilized by one or more volume sets. The volume sets associated with this RAID set appear for you to have chance to modify RAID level or stripe size. Follow the instruction presented in the “Modify Volume Set ” to modify the volume sets; operation system specific utilities may be required to expand operating system partitions.

Note:

1. Once the “Expand Raid Set” process has started, user can not stop it. The process must be completed.
2. If a disk drive fails during raid set expansion and a hot spare is available, an auto rebuild operation will occur after the RAID set expansion completes.
3. RAID set expansion is a quite critical process, we strongly recommend customer backup data before expand. Unexpected accident may cause serious data corruption.

6.5.4 Activate Incomplete Raid Set

If one of the disk drives is removed in power off state, the RAID set state will change to “Incomplete State”. If the user wants to continue to use the SATA RAID controller, the user can use the “Activate Raid Set” option to active the RAID set. After the user completes this function, the RAID set state will change to “Degraded Mode”.

WEB BROWSER-BASED CONFIGURATION



To activate the incomplete the RAID set, click on the “Activate Raid Set” link. A “Select The RAID SET To Activate” screen is displayed showing all RAID sets existing on the current controller. Click the RAID set number to activate in the select column. Click on the “Submit” button on the screen to activate the RAID set that had a disk removed (or failed) in the power off state. The SATA RAID controller will continue to work in degraded mode.

6.5.5 Create Hot Spare

When you choose the “Create Hot Spare” option in the “Raid Set Functions”, all unused physical devices connected to the current controller appear. Select the target disk by clicking on the appropriate check box. Click the “Confirm The Operation” check box and click the “Submit” button in the screen to create the hot spares.

The “Create Hot Spare” option gives you the ability to define a global hot spare.



WEB BROWSER-BASED CONFIGURATION

6.5.6 Delete Hot Spare

Select the target Hot Spare disk to be deleted by clicking on the appropriate check box.

Click the "Confirm The Operation" check box and click the "Submit" button on the screen to delete the hot spares.

6.5.7 Rescue Raid Set

When the system is powered off in the RAID set update/creation period, it possibly could disappear due to this abnormal condition. The "RESCUE" function can recover the missing RAID set information. The RAID controller uses the time as the RAID set signature. The RAID set may have different time after the RAID set is recovered. The "SIGANT" function can regenerate the signature for the RAID set.



6.5.8 Offline Raid Set

This function is for customer being able to unmount and remount a multi-disk volume. All Hdds of the selected RAID set will be put into offline state, spun down and fault LED in fast blinking mode. User can remove those Hdds and insert new Hdds on those empty slots without needing power down the controller.

6.6 Volume Set Functions

A volume set is seen by the host system as a single logical device. It is organized in a RAID level with one or more physical disks. RAID level refers to the level of data performance and protection of a volume set. A volume set capacity can consume all or a portion of the disk capacity available in a RAID set. Multiple volume sets can exist on a group of disks in a RAID set. Additional volume sets created in a specified RAID set will reside on all the physical disks in the RAID set. Thus each volume set on the RAID set will have its data spread evenly across all the disks in the RAID set.

6.6.1 Create Volume Set

1. Volume sets of different RAID levels may coexist on the same RAID set.
2. Up to 16 volume sets can be created by the SATA RAID controller.
3. The maximum addressable size of a single volume set is not limited to 2 TB because the controller is capable of 64-bit mode. However, the operating system itself may not be capable of addressing more than 2 TB. See the Areca website for details.



WEB BROWSER-BASED CONFIGURATION

To create a volume set on a RAID set, move the cursor bar to the main menu and click on the "Create Volume Set" link. This "Select The Raid Set To Create On It" screen will show all RAID set numbers. Click the RAID set number that to be used and then click the "Submit" button.

The "Enter Volume Attributeid Set=xx" option allows users to select the volume name, capacity, RAID level, strip size, SCSI ID/LUN, cache mode, and tag queuing.

- **Volume Name**

The default volume name will always appear as "Volume Set.#". You can rename the volume set providing it does not exceed the 15 characters limit.

- **Raid Level**

Set the RAID level for the volume set. Highlight the desired RAID Level and press **Enter** key. The available RAID levels for the current volume set are displayed. Select a RAID level and press "Enter" to confirm.

- **Capacity**

The maximum volume size is the default initial setting. Enter the appropriate volume size to fit your application.

- **Greater Two TB Volume Support**

If volume capacity exceeds 2TB, controller will show the "Greater Two TB Volume Support" sub-menu. Greater Two TB Volume Supports: No and 64bit LBA options.

For more details please download PDF file from **ftp://ftp.areca.com.tw/RaidCards/Documents/Manual_Spec/Over2TB_050721.zip**

- **Initialization Mode**

Press **Enter** key to define "Background Initialization", "Foreground Initialization" or "No Init (To Rescue Volume)". When "Background Initialization", the initialization proceeds as a background task, the volume set is fully accessible for system reads and writes. The operating system can instantly access to the newly created arrays without requiring a reboot and waiting the initialization complete. When "Foreground Initialization", the

WEB BROWSER-BASED CONFIGURATION

initialization proceeds must be completed before the volume set ready for system accesses. There is no initialization happed when you select "No Init" option. "No Init" is for customer to rescue volume without losing data in the disk.

- **Stripe Size**

This parameter sets the size of the stripe written to each disk in a RAID level 0, 1, 10, 5 or 6 logical drive. You can set the stripe size to 4 KB, 8 KB, 16 KB, 32 KB, 64 KB, or 128 KB.

A larger stripe size produces better read performance, especially if your computer does mostly sequential reads. However, if you are sure that your computer does random reads more often, select a smaller stripe size.

Note: RAID level 3 can't modify cache stripe size.

- **Cache Mode**

The SATA RAID controller supports "Write Through" and "Write Back" cache.

- **SCSI Channel/SCSI ID/SCSI Lun**

SCSI Channel: The SATA RAID controller function is simulated as a SCSI RAID controller. The host bus is represented as a SCSI channel. Choose the SCSI Channel.

SCSI ID: Each SCSI device attached to the SCSI card, as well as the card itself, must be assigned a unique SCSI ID number. A SCSI channel can connect up to 15 devices. The SATA RAID controller is a large SCSI device. Assign an ID from a list of SCSI IDs.

SCSI LUN: Each SCSI ID can support up to 8 LUNs. Most SATA RAID controllers treat each LUN like a SATA disk.

- **Tag Queuing**

The Enabled option is useful for enhancing overall system performance under multi-tasking operating systems. The Command Tag (Drive Channel) function controls the SCSI command tag queuing support for each drive channel. This function should normally remain enabled. Disable this function only when using older SATA drives that do not support command tag queuing

WEB BROWSER-BASED CONFIGURATION

6.6.2 Delete Volume Set

To delete a volume set from RAID set, move the cursor bar to the main menu and click on the "Delete Volume Set" link. The "Select The Raid Set To Delete" screen will show all RAID set numbers. Click a RAID set number and the "Confirm The Operation" check box and then click the "Submit" button to show all volume set items in the selected RAID set. Click a volume set number and the "Confirm The Operation" check box and then click the "Submit" button to delete the volume set.

The screenshot shows a web browser interface for Areca Technology Corporation. On the left is a navigation menu with categories: Quick Functions, Hard Disk Functions, Volume Set Functions, Physical Drives, System Controls, and Information. The main content area is titled "Select The Volume Set To Delete". It features a table with columns: Select, Volume Set Name, On RAID Set, and Capacity. One row is visible with a checked checkbox, "Volume Set 0 00", "RAID Set 0 00", and "100 (GB)". Below the table is a "Confirm The Operation" checkbox and "Submit" and "Cancel" buttons.

Select	Volume Set Name	On RAID Set	Capacity
<input checked="" type="checkbox"/>	Volume Set 0 00	RAID Set 0 00	100 (GB)

6.6.3 Modify Volume Set

To modify a volume set from a RAID set:

- (1). Click on the "Modify Volume Set" link.
- (2). Click the volume set check box from the list that you wish to modify. Click the "Submit" button. The following screen appears. Use this option to modify the volume set configuration. To modify volume set attributes, move the cursor bar to the volume set attribute menu and click it. The "Enter The Volume Attribute" screen appears. Move the cursor to an attribute item and then click the attribute to modify the value. After you complete the modification, click the "Confirm The Operation" check box and click the "Submit" button to complete the action. The user can modify all values except capacity.

6.6.3.1 Volume Growth

Use "Expand RAID Set" function to add disk to a RAID set. The additional capacity can be used to enlarge the last volume set size or to create another volume set. The "Modify Volume Set" function can support the "Volume Modification" function. To

WEB BROWSER-BASED CONFIGURATION

expand the last volume set capacity , move the cursor bar to the " Capacity" item and entry the capacity size. When finished the above action, press the **ESC** key and select the **Yes** option to complete the action. The last volume set starts to expand its capacity.

To expand an existing volume noticed:

- Only the last volume can expand capacity.
- When expand volume capacity, you can't modify stripe size or modify RAID level simultaneously.
- You can expand volume capacity, but can't reduce volume capacity size.
- After volume expansion, the volume capacity can't be decreased.

For greater 2TB expansion:

- If your system installed in the volume, don't expand the volume capacity greater 2TB, currently OS can't support boot up from a greater 2TB capacity device.
- Expand over 2TB used LBA64 mode. Please make sure your OS supports LBA64 before expand it.

6.6.3.2 Volume Set Migration

Migrating occurs when a volume set is migrating from one RAID level to another, when a volume set strip size changes, or when a disk is added to a RAID set. Migration status is displayed in the volume state area of the "Volume Set Information" screen.

The screenshot shows a web browser-based configuration interface for Areca Technology Corporation. The interface is divided into a sidebar on the left and a main content area on the right. The sidebar contains several menu items: 'Quick Function', 'Expand Set Functions', 'Volume Set Functions', 'Physical Drives', 'System Controls', and 'Information'. The main content area features a header with the Areca Technology Corporation logo and name. Below the header, there are two tables: 'RAID Set Hierarchy' and 'RAID Channels'.

RAID Set Hierarchy

RAID Set	RAID Channels	Volume Set (LBA Mode)	Volume State	Capacity
RAID Set #00	5:00	Volume Set #00 (5:00)	Migrating (P)	1.00 TGB
	5:01			
	5:02			
	5:03			

RAID Channels

Channel	Type	Capacity	Model
CH01	M.A	N.A	N.A
CH02	M.A	N.A	N.A
CH03	M.A	N.A	N.A
CH04	M.A	N.A	N.A
5:01	RAID Set #00	50.0GB	ST10013AS
5:02	RAID Set #00	50.0GB	ST10013AS

WEB BROWSER-BASED CONFIGURATION

6.6.4 Check Volume Set

To check a volume set from a RAID set:

- (1). Click on the "Check Volume Set" link.
- (2). Click on the volume set from the list that you wish to check. Tick on "Confirm The Operation" and click on the "Submit" button. Use this option to verify the correctness of the redundant data in a volume set. For example, in a system with dedicated parity, volume set check means computing the parity of the data disk drives and comparing the results to the contents of the dedicated parity disk drive. The checking percentage can also be viewed by clicking on "RaidSet Hierarchy" in the main menu.



6.6.5 Stop VolumeSet Check

Use this option to stop the "Check Volume Set function".



WEB BROWSER-BASED CONFIGURATION

6.7 Physical Drive

Choose this option to select a physical disk from the main menu and then perform the operations listed below.

6.7.1 Create Pass Through Disk

To create pass through disk, move the mouse cursor to the main menu and click on the "Create Pass Through" link. The "Select the IDE Drive For Pass Through" screen appears. A pass through disk is not controlled by the SATA RAID controller firmware, it cannot be a part of a volume set. The disk is available to the operating system as an individual disk. It is typically used on a system where the operating system is on a disk not controlled by the RAID firmware. The user can also select the Cache Mode, Tagged Command Queuing, SCSI channel/SCSI_ID/SCSI_LUN for this pass through disk.

Select	Channel	Capacity	Model
<input checked="" type="checkbox"/>	IDE CH0	30 000	ST30003AS
<input type="checkbox"/>	IDE CH1	30 000	ST30003AS
<input type="checkbox"/>	IDE CH2	30 000	ST30003AS

Enter Pass Through Disk Attribute

Volume Cache Mode:

Tagged Command Queuing:

SCSI Channel/ID/SCSI_Lun:

6.7.2 Modify Pass Through Disk

Use this option to modify the "Pass Through Disk Attribute". The user can modify the Cache Mode, Tagged Command Queuing, and SCSI channel/ID/LUN on an existing pass through disk. To modify the pass through drive attribute from the pass through drive pool, move the mouse cursor bar and click on the "Modify Pass Through" link. The "Select The Pass Through Disk For Modification" screen appears mark the checkbox for the pass through disk from the pass through drive pool and click on the "Submit" button to select drive.

WEB BROWSER-BASED CONFIGURATION

When the “Enter Pass Through Disk Attribute” screen appears, modify the drive attribute values, as you want. After you complete the selection, mark the check box for “Confirm The Operation” and click on the “Submit” button to complete the selection action.



6.7.3 Delete Pass Through Disk

To delete a pass through drive from the pass through drive pool, move the mouse cursor bar to the main menus and click the “Delete Pass Through” link. After you complete the selection, mark the check box for “Confirm The Operation” and click the “Submit” button to complete the delete action.



6.7.4 Identify Selected Drive

To prevent removal of the wrong drive, the selected fault LED will blink so as to physically locate the intended disk when “Identify Selected Drive” is selected.

To identify the selected drive from the drives pool, click “Identify Selected Drive”. The “Select The IDE Device For Identification”

WEB BROWSER-BASED CONFIGURATION

screen appears mark the check box for the SATA device from the drive pool. After completing the selection, click on the “Submit” button to identify selected drive.

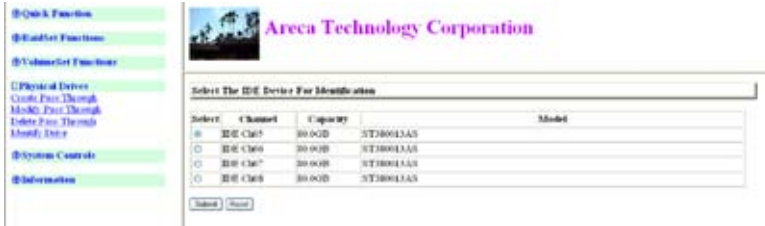

6.8 System Controls

6.8.1 System Config

To set the RAID system configuration, move the cursor to the main menu and click the “System Controls” link. The “System Controls” will show all items, then select the desired function.



- **System Beeper Setting**

The “System Beeper Setting” function item is used to “Disable” or “Enable” the SATA RAID controller alarm tone generator.

- **Background Task Priority**

The “Background Task Priority” is a relative indication of how much time the controller devotes to a rebuild operation. The SATA RAID controller allows the user to choose the rebuild priority (UltraLow, Low, Normal, High) to balance volume set access and rebuild tasks appropriately. For high array performance, specify a “Low” value.

WEB BROWSER-BASED CONFIGURATION

● **JBOD/RAID Configuration**

JBOD is an acronym for "Just a Bunch Of Disk". A group of hard disks in a RAID controllers are not set up as any type of RAID configuration. All drives are available to the operating system as an individual disk. JBOD does not provide data redundancy. User needs to delete the RAID set, when you want to change the option from the RAID to the JBOD function.

● **Maximun SATA Supported**

The SATA RAID controller can support up to SATA II, which runs up to 300MB/s. NCQ is a command protocol in Serial ATA that can only be implemented on native Serial ATA hard drives. It allows multiple commands to be outstanding within a drive at the same time. Drives that support NCQ have an internal queue where outstanding commands can be dynamically rescheduled or re-ordered, along with the necessary tracking mechanisms for outstanding and completed portions of the workload. The RAID subsystem allows user to choose the SATA mode (slowest to fastest): SATA150, SATA150+NCQ, SATA300, SATA300+NCQ.

● **HDD Read Ahead Cache**

Allow Read Ahead (Default: Enabled)—When Enabled, the drive's read ahead cache algorithm is used, providing maximum performance under most circumstances.

● **Volume Data Read Ahead**

The Read data ahead parameter specifies the controller firmware algorithms which process the Read Ahead data blocks from the disk. The Read Ahead parameter is normal by default. To modify the value, you must set it from the command line using the Read Ahead option. The default normal option satisfies the performance requirements for a typical volume. The disabled value implies no read ahead. The most efficient value for the controllers depends on your application. Aggressive read ahead is optimal for sequential access but it degrades random access.

● **Empty HDD Slot LED**

The firmware has added the "Empty HDD Slot LED" option to setup the fault LED light "ON "or "OFF" when there is no HDD installed. When each slot has a power LED for the HDD installed

WEB BROWSER-BASED CONFIGURATION

identify, user can set this option to "OFF". Choose option "ON", the SATA RAID controller will light the fault LED; if no HDD installed.

● **HDD SMART Status Polling**

An external RAID enclosure has the hardware monitor in the dedicated backplane that can report HDD temperature status to the controller. However, PCI type controllers do not use backplanes if the drives are internal to the main server chassis. The type of enclosure cannot report the HDD temperature to the controller. For this reason, "HDD SMART Status Polling" function was added to enable scanning of the HDD temperature function. It is necessary to enable "HDD SMART Status Polling" function before SMART information is accessible. This function is disabled by default.

The following screen shot shows how to change the setting to enable the polling function.

● **Auto Activate Incomplete Raid**

When some of the disk drives are removed in power off state or boot up stage, the RAID set state will change to "Incomplete State". But if a user wants to automatically continue to work while the SAS RAID controller is powered on, the user can set the "Auto Activate Incomplete Raid" option to enable. The RAID state will change to "Degraded Mode" while it powers on.

● **Disk Write Cache Mode**

A user can set the "Disk Write Cache Mode": Auto, Enabled, or Disabled.

● **Disk Capacity Truncation Mode**

SATA RAID controller use drive truncation so that drives from differing vendors are more likely to be able to be used as spares for each other. Drive truncation slightly decreases the usable capacity of a drive that is used in redundant units.

The controller provides three truncation modes in the system configuration: "Multiples Of 10G", "Multiples Of 1G", and "No Truncation".

WEB BROWSER-BASED CONFIGURATION

Multiples Of 10G: If you have 120 GB drives from different vendors; chances are that the capacity varies slightly. For example, one drive might be 123.5 GB, and the other 120 GB. "Multiples Of 10G" truncates the number under tens. This makes the same capacity for both of these drives so that one could replace the other.

Multiples Of 1G: If you have 123 GB drives from different vendors; chances are that the capacity varies slightly. For example, one drive might be 123.5 GB, and the other 123.4 GB. "Multiples Of 1G" truncates the fractional part. This makes the same capacity for both of these drives so that one could replace the other.

No Truncation: It does not truncate the capacity.

6.8.2 HDD Power Management

Areca has automated the ability to manage HDD power based on usage patterns. The "HDD Power Management" allows you to choose a "Stagger Power On Control", "Low Power Idle", "Low RPM" and completely "Spins Down Idle HDD". It is designed to reduce power consumption and heat generation on idle drives.

The screenshot shows a web browser-based configuration interface for Areca Technology Corporation. On the left is a navigation menu with categories: #Quick Function, #RaidSet Functions, #VolumeSet Functions, #Physical Drives, #System Controls, #Information, System Config, **Hdd Power Management** (highlighted in red), SMDP Configuration, View Events/Alerts/Reports, Generate Test Event, Clear Event Buffer, Modify Password, Upgrade Firmware. The main content area is titled "Hdd Power Management" and features the Areca Technology Corporation logo. It contains four settings, each with a dropdown menu: "Stagger Power On Control" (set to 07), "Time To Hdd Low Power Idle" (set to Disabled), "Time To Hdd Low RPM Mode" (set to Disabled), and "Time To Spin Down Idle HDD" (set to Disabled). Below these settings is a checkbox labeled "Confirm The Operation" and two buttons: "Submit" and "Reset".

WEB BROWSER-BASED CONFIGURATION

6.8.2.1 Stagger Power On Control

In a PC system with only one or two drives, the power can supply enough power to spin up both drives simultaneously. But in systems with more than two drives, the startup current from spinning up the drives all at once can overload the power supply, causing damage to the power supply, disk drives and other system components. This damage can be avoided by allowing the host to stagger the spin-up of the drives. The SAS/SATA drives have support stagger spin-up capabilities to boost reliability. Stagger spin-up is a very useful feature for managing multiple disk drives in a storage subsystem. It gives the host the ability to spin up the disk drives sequentially or in groups, allowing the drives to come ready at the optimum time without straining the system power supply. Staggering drive spin-up in a multiple drive environment also avoids the extra cost of a power supply designed to meet short-term startup power demand as well as steady state conditions.

Areca RAID controller has included the option for customer to select the disk drives sequentially stagger power up value. The values can be selected from 0.4s to 6s per step which powers up one drive.

6.8.2.2 Time to Hdd Low Power Idle

This option delivers lower power consumption by automatically unloading recording heads during the setting idle time.

6.8.2.3 Time To Hdd Low RPM Mode

This function can automatically spin disks at lower RPM if there have not been used during the setting idle time.

6.8.2.4 Time To Spin Down Idle HDD

This function can automatically spin down the drive if it hasn't been accessed for a certain amount of time. This value is used by the drive to determine how long to wait (with no disk activity, before turning off the spindle motor to save power.)

WEB BROWSER-BASED CONFIGURATION

6.8.3 Ethernet Configuration (Ethernet Port Support)

Use this feature to set the controller Ethernet port configuration. A customer doesn't need to create a reserved space on the arrays before the Ethernet port and HTTP service are working. The firmware-embedded Web Browser-based RAID storage manager can access it from any standard internet browser or from any host computer either directly connected or via a LAN or WAN with no software or patches required.

DHCP (Dynamic Host Configuration Protocol) is a protocol that lets network administrators manage centrally and automate the assignment of IP (Internet Protocol) configurations on a computer network. When using the internet's set of protocols (TCP/IP), in order for a computer system to communicate to another computer system, it needs a unique IP address. Without DHCP, the IP address must be entered manually at each computer system. DHCP lets a network administrator supervise and distribute IP addresses from a central point. The purpose of DHCP is to provide the automatic (dynamic) allocation of IP client configurations for a specific time period (called a lease period) and to eliminate the work necessary to administer a large IP network.

To configure the RAID controller Ethernet port, move the cursor bar to the main menu and click on the "System Controls" link. The "System Controls" menu will show all items. Move the cursor bar to the "EtherNet Config" item, then press "Enter" key to select the desired function.



The screenshot displays the web interface for configuring the RAID controller's Ethernet port. On the left is a navigation menu with categories: Quick Functions, Basic Functions, Advanced Functions, Physical Devices, and System Controls. The System Controls menu is expanded, showing options like System Config, RAID Power Management, Encrypted Config, Alert E-mail Config, ANSER Configuration, SFP Configuration, User Access/Status Report, Generate Test Log, User Access/Status, Monitor Password, Upgrade Firmware, and Information.

The main content area is titled "Ether Net Configuration" and includes the Areca Technology Corporation logo. It features a table for configuring network parameters:

Function	Enabled
Local IP Address (Used DHCP Disabled)	192.168.0.1
Gateway IP Address (Used DHCP Disabled)	192.168.0.1
Default Mask (Used DHCP Disabled)	255.255.255.0
HTTP Port Number (163.191.3 Reserved)	80
Telnet Port Number (768.019) Is Reserved	23
SMTP Port Number (768.019) Is Reserved	25
Current IP Address	192.168.0.179
Current Gateway IP Address	192.168.0.1
Current Subnet Mask	255.255.255.0
Ether Net MAC Address	00:04:8D:70:60:C3

At the bottom of the configuration area, there is a checkbox for "Enable The Operation" and "Submit" and "Cancel" buttons.

WEB BROWSER-BASED CONFIGURATION

6.8.4 Alert by Mail Configuration (Ethernet Port Support)

To configure the SATA RAID controller e-mail function, move the cursor bar to the main menu and click on the "System Controls" link. The "System Controls" menu will show all items. Move the cursor bar to the "Alert By Mail Config" item, then select the desired function. This function can only be set via web-based configuration.

The firmware contains a SMTP manager monitoring all system events. Single or multiple user notifications can be sent via "Plain English" e-mails with no software required.



6.8.5 SNMP Configuration (Ethernet Port Support)

To configure the RAID controller SNMP function, click on the "System Controls" link. The "System Controls" menu will show available items. Select the "SNMP Configuration" item. This function can only be set via web-based configuration.

The firmware SNMP agent manager monitors all system events and the SNMP function becomes functional with no agent software required.

WEB BROWSER-BASED CONFIGURATION

SNMP Trap IP Address		
SNMP Trap #1 Address	<input type="text"/>	Port: <input type="text"/>
SNMP Trap #2 Address	<input type="text"/>	Port: <input type="text"/>
SNMP Trap #3 Address	<input type="text"/>	Port: <input type="text"/>

SNMP System Configurations	
Community	<input type="text"/>
sysContact	<input type="text"/>
sysName	<input type="text"/>
sysLocation	<input type="text"/>

SNMP Trap Notification Configurations	
<input type="checkbox"/> Enable SNMP Trap	<input type="checkbox"/> No SNMP Trap Will Be Sent
<input type="checkbox"/> Urgent Error Notification	<input type="checkbox"/> Send Only Urgent Event
<input type="checkbox"/> General Error Notification	<input type="checkbox"/> Send Urgent And General Event
<input type="checkbox"/> Warning Error Notification	<input type="checkbox"/> Send Urgent, General And Warning Event
<input type="checkbox"/> Information Notification	<input type="checkbox"/> Send All Event

- **SNMP Trap Configurations**

Enter the SNMP Trap IP Address.

- **SNMP System Configurations**

About community, please refer to Appendix C of SNMP community name. The system Contact, Name and Location that will be shown in the outgoing SNMP Trap.

- **SNMP Trap Notification Configurations**

Please refer to Appendix D of Event Notification Table.

6.8.6 NTP Configuration (Ethernet Port Support)

The “Network Time Protocol (NTP)” is used to synchronize the time of a computer client or server to another server or reference time source, such as a radio or satellite receiver or modem. It provides accuracies typically within a millisecond on LANs and up to a few tens of milliseconds on WANs relative to Coordinated Universal Time (UTC) via a Global Positioning Service (GPS) receiver, for example:

WEB BROWSER-BASED CONFIGURATION



● NTP Server Address

The most important factor in providing accurate, reliable time is the selection of NTP servers to be used in the configuration file. Typical NTP configurations utilize multiple redundant servers and diverse network paths in order to achieve high accuracy and reliability. Our NTP configuration supports two existing public NTP synchronization subnets.

● Time Zone

The "Time Zone" conveniently runs in the system tray and allows you to view the date and time in various locations around the world easily. You are also able to add your own personal locations to customize time zone the way you want with great ease and less hassle.

● Automatic Daylight Saving

The "Automatic Daylight Saving" will normally attempt to automatically adjust the system clock for daylight saving changes based on the computer time zone. This tweak allows you to disable the automatic adjustment.

Note:

NTP feature works through onboard Ethernet port. So you must make sure that you have connected onboard Ethernet port.

WEB BROWSER-BASED CONFIGURATION

6.8.7 View Events/Mute Beeper

To view the SATA RAID controller's information, click on the "View Events/Mute Beeper" link. The SATA RAID controller "System Events information" screen appears.

Choose this option to view the system events information: Timer, Device, Event type, Elapse Time and Errors. The RAID system does not have a built-in real time clock. The time information is the relative time from the SATA RAID controller power on.



The screenshot shows the web interface for the SATA RAID controller. On the left is a navigation menu with options like 'Quick Functions', 'Health Functions', 'Advanced Functions', 'Physical Drives', 'System Controls', and 'Information'. The 'Physical Drives' section is expanded, showing a list of links including 'System Config', 'RAID Drive Management', 'Advanced Config', 'Alert By Mail Config', 'SNMP Configuration', 'NTP Configuration', 'View & Export Logs (Reports)', 'Generate Test Event', 'Clear Event Buffer', 'Health Parameters', and 'Upgrade Firmware'. The main content area displays the 'System Events Information' table, which lists various events with columns for Time, Device, Event Type, Elapse Time, and Errors.

Time	Device	Event Type	Elapse Time	Errors
2005-12-14 14:02:51	AAC-1245-VLE01	Complete Init		
2005-12-14 14:17:57	102-148-000-106	HTTP Log In		
2005-12-14 14:17:48	AAC-1245-VLE01	Start Initiate		
2005-12-14 14:17:11	HW Monitor	Fail Processed On		
2005-12-14 14:56:51	AAC-1245-VLE01	Complete Init	0000:59	
2005-12-14 14:12:12	102-148-000-106	HTTP Log In		
2005-12-14 14:11:41	AAC-1245-VLE01	Start Initiate		
2005-12-14 14:03:05	HW Monitor	Fail Processed On		
2005-12-14 14:03:05	AAC-1245-VLE01	Complete Init	0000:59	
2005-12-14 14:03:58	AAC-1245-VLE01	Start Initiate		
2005-12-14 14:03:05	AAC-1245-VLE01	Complete Init		
2005-12-14 14:33:05	RAID Terminal	VTail Log In		
2005-12-14 14:33:05	HW Monitor	Fail Processed On		
2005-12-14 14:41:48	102-148-000-106	HTTP Log In		

6.8.8 Generate Test Event

This feature is used to generate events for testing purposes.



The screenshot shows the web interface for the SATA RAID controller. On the left is a navigation menu with options like 'Quick Functions', 'Health Functions', 'Advanced Functions', 'Physical Drives', 'System Controls', and 'Information'. The 'Physical Drives' section is expanded, showing a list of links including 'System Config', 'RAID Drive Management', 'Advanced Config', 'Alert By Mail Config', 'SNMP Configuration', 'NTP Configuration', 'View & Export Logs (Reports)', 'Generate Test Event', 'Clear Event Buffer', 'Health Parameters', and 'Upgrade Firmware'. The main content area displays a dialog box titled 'Do You Want To Generate Test Event?' with a 'Generate Test Event' button and a 'Cancel' button.

WEB BROWSER-BASED CONFIGURATION

6.8.9 Clear Events Buffer

Use this feature to clear the entire events buffer information.



6.8.10 Modify Password

To set or change the SATA RAID controller password, select “Modify Password” from the menu and click on the “Modify Password” link. The “Modify System Password” screen appears.

The manufacture default password is set to 0000. The password option allows user to set or clear the SATA RAID controller’s password protection feature. Once the password has been set, the user can only monitor and configure the SATA RAID controller by providing the correct password.

The password is used to protect the SATA RAID controller from unauthorized entry. The controller will check the password only when entering the main menu from the initial screen. The SATA RAID controller will automatically go back to the initial screen when it does not receive any command in 5 minutes. Do not use spaces when you enter the password, If spaces are used, it will lock out the user. To disable the password, leave the fields blank. Once the user confirms the operation and clicks the “Submit” button, the existing password will be cleared. After which, no password checking will occur when entering the main menu from the starting screen.

WEB BROWSER-BASED CONFIGURATION



6.8.11 Update Firmware

Please refer to the appendix A Upgrading Flash ROM Update Process.



6.9 Information

6.9.1 RaidSet Hierarchy

Use this feature to view the SATA RAID controller current RAID set, current volume set and physical disk configuration. Please reference this chapter "Configuring Raid Sets and Volume Sets".

WEB BROWSER-BASED CONFIGURATION



6.9.2 System Information

To view the SATA RAID controller's information, move the mouse cursor to the main menu and click on the "System Information" link. The "Raid Subsystem Information" screen appears.

Use this feature to view the SATA RAID controller's information. The controller name, firmware version, serial number, main processor, CPU data/instruction cache size and system memory size/speed appear in this screen.



WEB BROWSER-BASED CONFIGURATION

6.9.3 Hardware Monitor

To view the RAID controller's hardware monitor information, move the mouse cursor to the main menu and click the "Hardware Monitor" link. The "Hardware Monitor Information" screen appears.

The "Hardware Monitor Information" provides the temperature, and fan speed (I/O Processor fan) of the SATA RAID controller.

The ARC-1231/1261/1280/1280ML card interface lists two temperatures; one for the I/O processor and the other one for the controller. The I/O processor temperature is a new feature which detects by a thermal sensor under the IOP341. The processor safe range is 90 Celsius degree and the controller safe range is 70 Celsius degree. If any sensor detects over the safe ranges on these temperatures, you will get a warning event.



The screenshot displays the web browser-based configuration interface for Areca Technology Corporation. The interface is divided into a left-hand navigation menu and a main content area. The navigation menu includes links for "Check Functions", "Monitor Functions", "Information Functions", "Physical Drive", "System Control", "Diagnosis", "Factory Restore", "Default Configuration", and "Language/Display". The main content area features the Areca Technology Corporation logo and a "Hardware Monitor Information" section. This section contains a table with the following data:

Hardware Monitor Information	
Fan Speed	1018 RPM
System Temp	38.6°C
IO341 Temperature	38.7°C
IO342 Temperature	38.7°C
IO343 Temperature	38.7°C
IO344 Temperature	38.7°C
IO345 Temperature	38.7°C
IO346 Temperature	38.7°C
IO347 Temperature	38.7°C
IO348 Temperature	38.7°C
IO349 Temperature	38.7°C
IO350 Temperature	38.7°C
IO351 Temperature	38.7°C
IO352 Temperature	38.7°C
IO353 Temperature	38.7°C
IO354 Temperature	38.7°C
IO355 Temperature	38.7°C
IO356 Temperature	38.7°C
IO357 Temperature	38.7°C
IO358 Temperature	38.7°C

APPENDIX

Appendix A

Upgrading Flash ROM Update Process

Since the SATA RAID controller features flash firmware, it is not necessary to change the hardware flash chip in order to upgrade the RAID firmware. The user can simply re-program the old firmware through the In-Band PCI-X/PCIe bus or Out-of-Band Ethernet port McRAID storage manager. New releases of the firmware are available in the form of a DOS file on the shipped CD or Areca's web site. The files available at the FTP site for each model contain the following files in each version:

ARCXXXXNNNN.BIN Software Binary Code (where "XXXX" refers to the model name and "NNNN" refers to the software code type)

ARCXXXXBIOS.BIN :→ PCI card BIOS for system board using

ARCXXXXBOOT.BIN :→ RAID controller hardware initialization

ARCXXXXFIRM.BIN :→ RAID kernel program

ARCXXXXMBR0.BIN:→ Master Boot Record for supporting Dual Flash Image in the SATA II RAID controller

README.TXT contains the history information of the software code change in the main directory. Read this file first to make sure you are upgrading to the proper binary file. Select the right file for the upgrade. Normally, user upgrades the ARCXXXXBIOS.BIN for system M/B compatibility and ARCXXXXFIRM.BIN for RAID function upgrades.

Note:

Please update all Binary Code (BIOS, BOOT, FIRM and MBR0) before you reboot system. Otherwise, a mixed firmware package may hang the controller.

Upgrading Firmware Through McRAID Storage Manager

Get the new version firmware for your SATA RAID controller. For example, download the bin file from your OEM's web site onto the C: drive



1. To upgrade the RAID controller firmware, move the mouse cursor to "Upgrade Firmware" link. The "Upgrade The Raid System Firmware" screen appears.
2. Click "Browser". Look in the location to which the firmware upgrade software was downloaded. Select the file name and click "Open". All files (BIOS, BOOT, FIRM and MBR0) can be updated through this function.
3. Click "Confirm The Operation" and press the "Submit" button.
4. The web browser begins to download the firmware binary to the controller and start to update the flash ROM.
5. After the firmware upgrade is complete, a bar indicator will show "Firmware Has Been Updated Successfully"
6. After the new firmware has completed downloading, find a chance to restart the controller/computer for the new firmware to take effect.

The web browser-based McRAID storage manager can be accessed through the In-Band PCI-X/PCIe bus or Out-of-Band LAN port. The In-Band method uses the ArchHttp proxy server to launch the McRAID storage manager. The Out-of-Band method allows local or remote to access the McRAID storage manager from any standard internet browser via a LAN or WAN with no software or patches required.

Controller with onboard LAN port, you can directly plug an Ethernet cable to the controller LAN port, then enter the McBIOS RAID manager to configure the network setting. After network setting configured and saved, you can find the current IP address in the "System Information" page.

APPENDIX

From a remote PC, you can directly open a web browser and enter the IP address. Then enter user name and password to login and start your management. You can find the firmware update feature in the browser console: "System Controls" option.

Upgrading Firmware Through nflash DOS Utility

Areca now offers an alternative means communication for the SATA RAID controller – Upgrade the all files (BIOS, BOOT, FIRM and MBR0) without necessary system starting up to running the ArchHttp proxy server. The nflash utility program is a DOS application, which runs in the DOS operating system. Be sure of ensuring properly to communicate between SATA RAID controller and nflash DOS utility. Please make a bootable DOS floppy diskette or UBS devices from other Windows operating system and boot up the system from those bootable devices.

● Starting the nflash Utility

You do not need to short any jumper cap on running nflash utility. The nflash utility provides an on-line table of contents, brief descriptions of the help sub-commands. The nflash utility put on the <CD-ROM>\Firmware directory. You can run the <nflash> to get more detailed information about the command usage. Typical output looks as below:

```
A:\nflash
Raid Controller Flash Utility
V1.11 2007-11-8
Command Usage:
NFLASH FileName
NFLASH FileName /cn --> n=0,1,2,3 write binary to controller#0
FileName May Be ARC1110FIRM.BIN or ARC1210*
For ARC1110* Will Expand To ARC1110BOOT /FIRM/BIOS.BIN

A:\>nflash arc1210FIRM.BIN
Raid Controller Flash Utility
V1.11 2007-11-8
NODEL : ARC-1110
MEM FE620000 FE7FF000
File ARC1110FIRM.BIN : >>*** => Flash OK
```

Upgrading Firmware Through CLI

This Command Line Interface (CLI) provides you to configure and manage the Areca SAS RAID controller components in Windows, Linux, FreeBSD and more environments. The CLI is useful in environments where a graphical user interface (GUI) is not available. Through the CLI, you perform firmware upgrade that you can perform with the McRAID storage manager GUI. From firmware version 1.43 and CLI version 1.72.250 beginning, the controller has added the firmware update through the CLI on the controller.

To update the controller firmware, follow the procedure below:

```
Parameter: <path=<PATH_OF_FIRMWARE_FILE>>
```

```
Fn: Firmware Updating.
```

```
Ex: Update Firmware And File Path Is In [C:\FW\ARC1110FIRM.BIN.]
```

```
Command: sys updatefw path=c:\fw\arc1110firm.bin [Enter]
```

Note:

Areca SAS and SATA II RAID controller firmware version 1.43 date: Feb 2007 and later has supported the ATA-8 spec for HDD microcode download, allowing customer using nflash DOS utility or web browser to upgrade ATA-8 spec for microcode download supported HDD's firmware connected with Areca's entire family RAID controllers without necessary removing any single drive and upgrade. Areca has provided one utility for customer to make the ATA-8 spec for microcode download drive's firmware for readable by Areca firmware.

APPENDIX

Appendix B

Battery Backup Module (ARC6120-BAT-xxx)

The SATA RAID controller operates using cache memory. The Battery Backup Module is an add-on module that provides power to the SATA RAID controller cache memory in the event of a power failure. The Battery Backup Module monitors the write back cache on the SATA RAID controller, and provides power to the cache memory if it contains data not yet written to the hard drives when power failure occurs.

BBM Components

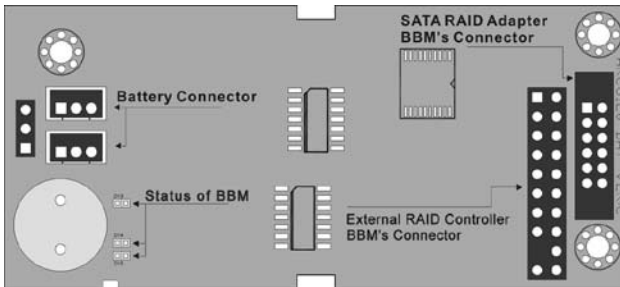

Status of BBM

- D13 (Green) : lights when BBM activated
- D14 (Red) : lights when BBM charging
- D15 (Green) : lights when BBM normal

Installation

1. Make sure all power to the system is disconnected.
2. Connector J1 is available for the optional battery backup module. Connect the BBM cable to the 12-pin battery connector on the controller.
3. Integrators may provide pre-drilled holes in their cabinet for securing the BBM using its three mounting positions.

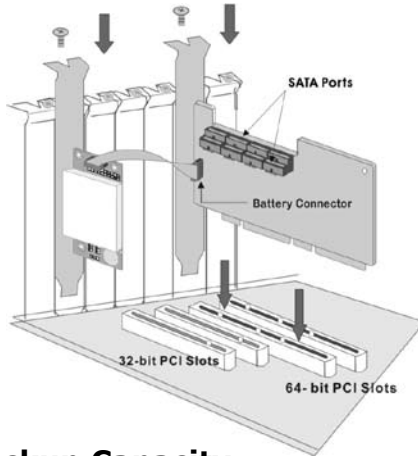

Battery Backup Capacity

Battery backup capacity is defined as the maximum duration of a power failure for which data in the cache memory can be maintained by the battery. The BBM's backup capacity varied with the memory chips that installed on the SATA RAID controller.

Capacity	Memory Type	Battery Backup duration (Hours)
128MB DDR	Low Power (18mA)	56

Operation

1. Battery conditioning is automatic. There are no manual procedures for battery conditioning or preconditioning to be performed by the user.
2. In order to make sure of all the capacity is available for your battery cells, allow the battery cell to be fully charged when installed for the first time. The first time charge of a battery cell takes about 24 hours to complete.

Changing the Battery Backup Module

At some point, the LI-ION battery will no longer accept a charge properly. LI-ION battery life expectancy is anywhere from approximately 1 to 5 years.

1. Shutdown the operating system properly. Make sure that cache memory has been flushed.

APPENDIX

2. Disconnect the BBM cable from J2 on the RAID controller.
3. Disconnect the battery pack cable from JP2 on the BBM.
4. Install a new battery pack and connect the new battery pack to JP2.
5. Connect the BBM to J2 on the SATA RAID controller.
6. Disable the write-back function from the McBIOS or Utility.

Note:

Do not remove BBM while system is running.

Battery Functionality Test Procedure:

1. Writing amount of data into controller volume, about 5GB or bigger.
2. Waiting for few seconds, power failed system by remove the power cable
3. Check the battery status, make sure the D13 is bright light, and battery beeps every few seconds.
4. Power on system, and press Tab/F6 to login controller.
5. Check the controller event log, make sure the event shows controller boot up with power recovered.

BBM Specifications

Mechanical

- Module Dimension (W x H x D)
37.3 x 13 x 81.6 mm
- BBM Connector
2 * 6 box header

Environmental

- Operating Temperature
Temperature: -25° C to +60° C
- Humidity: 45-85%, non-condensing
- Storage Temperature
Temperature: -40° C to 85° C
- Humidity: 45-85%, non-condensing

Electrical

- Input Voltage
+3.6VDC
- On Board Battery Capacity
1100mAH (1*1100mAH)

Appendix C

SNMP Operation & Definition

Overview

The McRAID storage manager includes a firmware-embedded Simple Network Management Protocol (SNMP) agent and SNMP Extension Agent for the SATA RAID controller. An SNMP-based management application (also known as an SNMP manager) can monitor the disk array. An example of An SNMP management application is Hewlett-Packard's Open View. The SNMP Extension Agent can be used to augment the SATA RAID controller if you are already running an SNMP management application at your site.

SNMP Definition

SNMP, an IP-based protocol, has a set of commands for getting the status of target devices. The SNMP management platform is called the SNMP manager, and the managed devices have the SNMP agent loaded. Management data is organized in a hierarchical data structure called the Management Information Base (MIB). These MIBs are defined and sanctioned by various industry associations. The objective is for all vendors to create products in compliance with these MIBs so that inter-vendor interoperability can be achieved. If a vendor wishes to include additional device information that is not specified in a standard MIB, then that is usually done through MIB extensions.

APPENDIX

MIB Compilation and Definition File Creation

Before the manager application accesses the SATA RAID controller, it is necessary to integrate the MIB into the management application's database of events and status indicator codes. This process is known as compiling the MIB into the application. This process is highly vendor-specific and should be well-covered in the User's Guide of your SNMP application. Ensure the compilation process successfully integrates the contents of the ARECARAID.MIB file into the traps database.

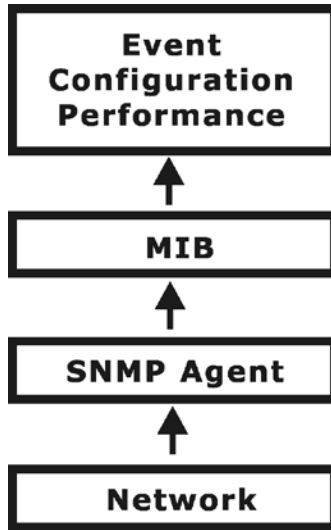

SNMP Installation

The installation of the SNMP manager is accomplished in several phases:

- Starting the firmware-embedded SNMP community configuration.
- Installing the SNMP Extension Agent on the server
- Installing the SNMP manager software on the client
- Placing a copy of the Management Information Base (MIB) in a directory which is accessible to the management application
- Compiling the MIB description file with the management application

Starting the SNMP Function Setting



● Community Name

Community name acts as a password to screen accesses to the SNMP agent of a particular network device. Type in the community names of the SNMP agent. Before access is granted to a request station, this station must incorporate a valid community name into its request; otherwise, the SNMP agent will deny access to the system.

Most network devices use “public” as default of their community names. This value is case-sensitive.

SNMP Extension Agent Installation for Windows

You must have the administrative level permission to install SATA RAID software. This procedure assumes that the SATA RAID hardware and Windows are both installed and operational in your system.

To enable the SNMP agent for Windows, configure Windows for TCP/IP and SNMP services. The Areca SNMP Extension Agent file is ARCSNMP.DLL.

Screen captures in this section are taken from a Windows XP installation. If you are running another version of Windows, your screens may look different, but the Areca SNMP Extension Agent installation is essentially the same.

1. Insert the SATA RAID controller CD in the CD-ROM drive.

APPENDIX

2. Run the setup.exe file that resides at: <CD-ROM>\packages\windows\http\setup.exe on the CD-ROM. (If SNMP service was not installed, please install SNMP service first.)



3. Click on the "Setup.exe" file then the welcome screen appears.



4. Click the "Next" button and then the "Ready Install the Program" screen appears. Follow the on-screen prompts to complete Area SNMP Extension Agent installation.



5. A Progress bar appears that measures the progress of the Areca SNMP Extension Agent setup. When this screen complete, you have completed the Areca SNMP Extension Agent setup.

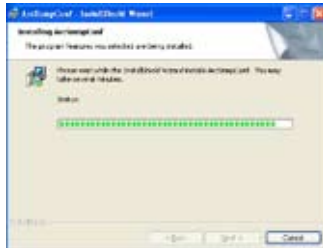

6. After a successful installation, the "InstallShield Wizard Completed" dialog box of the installation program is displayed. Click the "Finish" button to complete the installation.



Starting SNMP Trap Notification Configurations

To start "SNMP Trap Notification Configurations", There have two methods. First, double-click on the "Areca Raid Controller".



Second, you may also use the "Taskbar Start/programs/Areca Technology Corp/ArcSnmpConf" menus shown below.

APPENDIX

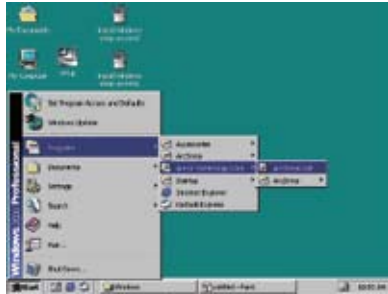

SNMP Community Configurations

Please refer to the community name in this appendix.

SNMP Trap Notification Configurations

The "Community Name" should be the same as firmware-embedded SNMP community. The "SNMP Trap Notification Configurations" include level 1: Serious, level 2: Error, level 3: Warning and level 4: Information. The level 4 covers notification events such as initialization of the controller and initiation of the rebuilding process; Level 3 includes events which require the issuance of warning messages; Level 2 covers notification events which once have happen; Level 1 is the highest level, and covers events the need immediate attention (and action) from the administrator.



SNMP Extension Agent Installation for Linux

You must have administrative level permission to install SATA RAID software. This procedure assumes that the SATA RAID

hardware and Linux are installed and operational in your system. For the SNMP Extension Agent Installation for Linux procedure, please refer to **<CD-ROM>\packages\Linux\SNMP\Readme** or download from **<http://www.areca.com.tw>**

SNMP Extension Agent Installation for FreeBSD

You must have administrative level permission to install SATA RAID software. This procedure assumes that the SATA RAID hardware and FreeBSD are installed and operational in your system. For the SNMP Extension Agent Installation for FreeBSD procedure please refer to **<CD-ROM>\packages\FreeBSD\SNMP\Readme** or download from **<http://www.areca.com.tw>**

APPENDIX

Appendix D

Event Notification Configurations

The controller classifies disk array events into four levels depending on their severity. These include level 1: Urgent, level 2: Serious, level 3: Warning and level 4: Information. The level 4 covers notification events such as initialization of the controller and initiation of the rebuilding process; Level 2 covers notification events which once have happen; Level 3 includes events which require the issuance of warning messages; Level 1 is the highest level, and covers events the need immediate attention (and action) from the administrator. The following lists sample events for each level:

A. Device Event

Event	Level	Meaning	Action
Device Inserted	Warning	HDD inserted	
Device Removed	Warning	HDD removed	
Reading Error	Warning	HDD reading error	Keep Watching HDD status, may be it caused by noise or HDD unstable.
Writing Error	Warning	HDD writing error	Keep Watching HDD status, may be it caused by noise or HDD unstable.
ATA Ecc Error	Warning	HDD ECC error	Keep Watching HDD status, may be it caused by noise or HDD unstable.
Change ATA Mode	Warning	HDD change ATA mode	Check HDD connection
Time Out Error	Warning	HDD time out	Keep Watching HDD status, maybe it caused by noise or HDD unstable.
Device Failed	Urgent	HDD failure	Replace HDD
PCI Parity Error	Serious	PCI parity error	If only happen once, it may be caused by noise. If always happen, please check power supply or contact to us.
Device Failed(SMART)	Urgent	HDD SMART failure	Replace HDD

PassThrough Disk Created	Inform	Pass Through Disk created	
PassThrough Disk Modified	Inform	Pass Through Disk modified	
PassThrough Disk Deleted	Inform	Pass Through Disk deleted	

B. Volume Event

Event	Level	Meaning	Action
Start Initialize	Warning	Volume initialization has started	
Start Rebuilding	Warning	Volume rebuilding has started	
Start Migrating	Warning	Volume migration has started	
Start Checking	Warning	Volume parity checking has started	
Complete Init	Warning	Volume initialization completed	
Complete Rebuild	Warning	Volume rebuilding completed	
Complete Migrate	Warning	Volume migration completed	
Complete Check	Warning	Volume parity checking completed	
Create Volume	Warning	New volume created	
Delete Volume	Warning	Volume deleted	
Modify Volume	Warning	Volume modified	
Volume Degraded	Urgent	Volume degraded	Replace HDD
Volume Failed	Urgent	Volume failure	
Failed Volume Revived	Urgent	Failed Volume revived	
Abort Initialization	Warning	Initialization been aborted	
Abort Rebuilding	Warning	Rebuilding aborted	
Abort Migration	Warning	Migration aborted	
Abort Checking	Warning	Parity check aborted	
Stop Initialization	Warning	Initialization stopped	
Stop Rebuilding	Warning	Rebuilding stopped	
Stop Migration	Warning	Migration stopped	
Stop Checking	Warning	Parity check stopped	

APPENDIX

C. RAID Set Event

Event	Level	Meaning	Action
Create RaidSet	Warning	New raidset created	
Delete RaidSet	Warning	Raidset deleted	
Expand RaidSet	Warning	Raidset expanded	
Rebuild RaidSet	Warning	Raidset rebuilding	
RaidSet Degraded	Urgent	Raidset degraded	Replace HDD

D. Hardware Monitor Event

Event	Level	Meaning	Action
DRAM 1-Bit ECC	Urgent	DRAM 1-Bit ECC error	Check DRAM
DRAM Fatal Error	Urgent	DRAM fatal error encountered	Check the DRAM module and replace with new one if required.
Controller Over Temperature	Urgent	Abnormally high temperature detected on controller (over 60 degree)	Check air flow and cooling fan of the enclosure, and contact us.
Hdd Over Temperature	Urgent	Abnormally high temperature detected on Hdd (over 55 degree)	Check air flow and cooling fan of the enclosure.
Fan Failed	Urgent	Cooling Fan # failure or speed below 1700RPM	Check cooling fan of the enclosure and replace with a new one if required.
Controller Temp. Recovered	Serious	Controller temperature back to normal level	
Hdd Temp. Recovered			
Raid Power On	Warning	Raid power on	
Test Event	Urgent	Test event	
Power On With Battery Backup	Warning	Raid power on with battery backup	
Incomplete RAIDDiscovered	Serious	Some RAID set member disks missing before power on	Check disk information to find out which channel missing.
HTTP Log In	Serious	a HTTP login detected	

APPENDIX

Telnet Log	Serious	a Telnet login detected	
InVT100 Log In	Serious	a VT100 login detected	
API Log In	Serious	a API login detected	
Lost Rebuilding/ MigrationLBA	Urgent	Some rebuilding/ migration raidset member disks missing before power on.	Reinserted the missing member disk back, controller will continue the incompleted rebuilding/ migration.

Note:

It depends on models, not every model will encounter all events.

APPENDIX

Appendix E

RAID Concept

RAID Set

A RAID set is a group of disks connected to a RAID controller. A RAID set contains one or more volume sets. The RAID set itself does not define the RAID level (0, 1, 10(1E), 3, 5, 6, etc); the RAID level is defined within each volume set. Therefore, volume sets are contained within RAID sets and RAID Level is defined within the volume set. If physical disks of different capacities are grouped together in a RAID set, then the capacity of the smallest disk will become the effective capacity of all the disks in the RAID set.

Volume Set

Each volume set is seen by the host system as a single logical device (in other words, a single large virtual hard disk). A volume set will use a specific RAID level, which will require one or more physical disks (depending on the RAID level used). RAID level refers to the level of performance and data protection of a volume set. The capacity of a volume set can consume all or a portion of the available disk capacity in a RAID set. Multiple volume sets can exist in a RAID set. For the SATA RAID controller, a volume set must be created either on an existing RAID set or on a group of available individual disks (disks that are about to become part of a RAID set). If there are pre-existing RAID sets with available capacity and enough disks for the desired RAID level, then the volume set can be created in the existing RAID set of the user's choice.

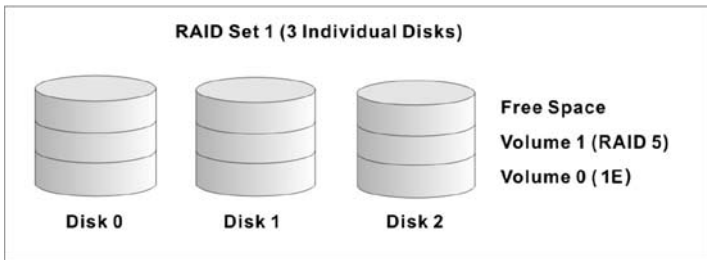

In the illustration, volume 1 can be assigned a RAID level 5 of operation while volume 0 might be assigned a RAID level 10 of operation. Alternatively, the free space can be used to create volume 2, which could then be set to use RAID level 5.

Ease of Use Features

• Foreground Availability/Background Initialization

RAID 0 and RAID 1 volume sets can be used immediately after creation because they do not create parity data. However, RAID 3, 5 and 6 volume sets must be initialized to generate parity information. In background Initialization, the initialization proceeds as a background task, and the volume set is fully accessible for system reads and writes. The operating system can instantly access the newly created arrays without requiring a reboot and without waiting for initialization to complete. Furthermore, the volume set is protected against disk failures while initialing. If using Foreground Initialization, the initialization process must be completed before the volume set is ready for system accesses.

• Online Array Roaming

The SATA RAID controllers store RAID configuration information on the disk drives. The controller therefore protects the configuration settings in the event of controller failure. Array roaming allows the administrators the ability to move a completed RAID set to another system without losing RAID configuration information or data on that RAID set. Therefore, if a server fails, the RAID set disk drives can be moved to another server with an Areca RAID controller and the disks can be inserted in any order.

• Online Capacity Expansion

Online Capacity Expansion makes it possible to add one or more physical drives to a volume set without interrupting server operation, eliminating the need to backup and restore after reconfiguration of the RAID set. When disks are added to a RAID set, unused capacity is added to the end of the RAID set. Then, data

APPENDIX

on the existing volume sets (residing on the newly expanded RAID set) is redistributed evenly across all the disks. A contiguous block of unused capacity is made available on the RAID set. The unused capacity can be used to create additional volume sets.

A disk, to be added to a RAID set, must be in normal mode (not failed), free (not spare, in a RAID set, or passed through to host) and must have at least the same capacity as the smallest disk capacity already in the RAID set.

Capacity expansion is only permitted to proceed if all volumes on the RAID set are in the normal status. During the expansion process, the volume sets being expanded can be accessed by the host system. In addition, the volume sets with RAID level 1, 10, 3, 5 or 6 are protected against data loss in the event of disk failure(s). In the case of disk failure, the volume set changes from "migrating" state to "migrating+degraded" state. When the expansion is completed, the volume set would then change to "degraded" mode. If a global hot spare is present, then it further change to the "rebuilding" state.

The expansion process is illustrated as following figure.

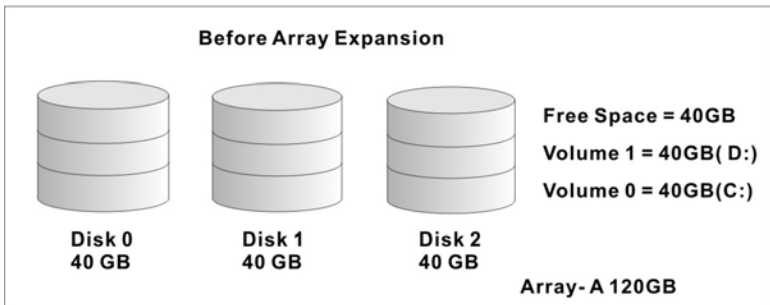

The SATA RAID controller redistributes the original volume set over the original and newly added disks, using the same fault-tolerance configuration. The unused capacity on the expand RAID set can then be used to create an additional volume set, with a different fault tolerance setting (if required by the user.)

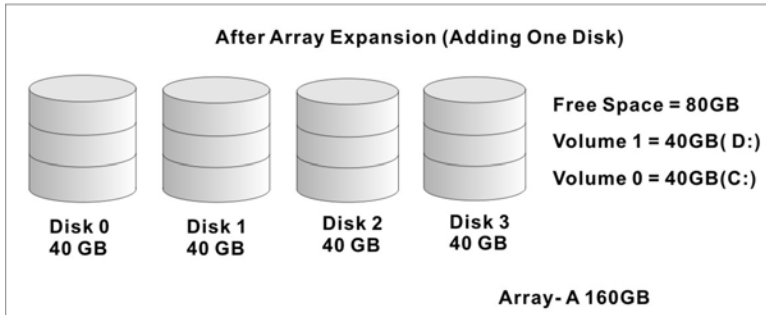

• Online RAID Level and Stripe Size Migration

For those who wish to later upgrade to any RAID capabilities, a system with Areca online RAID level/stripe size migration allows a simplified upgrade to any supported RAID level without having to reinstall the operating system.

The SATA RAID controllers can migrate both the RAID level and stripe size of an existing volume set, while the server is online and the volume set is in use. Online RAID level/stripe size migration can prove helpful during performance tuning activities as well as when additional physical disks are added to the SATA RAID controller. For example, in a system using two drives in RAID level 1, it is possible to add a single drive and add capacity and retain fault tolerance. (Normally, expanding a RAID level 1 array would require the addition of two disks). A third disk can be added to the existing RAID logical drive and the volume set can then be migrated from RAID level 1 to 5. The result would be parity fault tolerance and double the available capacity without taking the system down. A fourth disk could be added to migrate to RAID level 6. It is only possible to migrate to a higher RAID level by adding a disk; disks in an existing array can't be reconfigured for a higher RAID level without adding a disk. Online migration is only permitted to begin, if all volumes to be migrated are in the normal mode. During the migration process, the volume sets being migrated are accessed by the host system. In addition, the volume sets with RAID level 1, 10, 3, 5 or 6 are protected against data loss in the event of disk failure(s). In the case of disk failure, the volume set transitions from migrating state to (migrating+degraded) state. When the migration

APPENDIX

is completed, the volume set transitions to degraded mode. If a global hot spare is present, then it further transitions to rebuilding state.

• Online Volume Expansion

Performing a volume expansion on the controller is the process of growing only the size of the latest volume. A more flexible option is for the array to concatenate an additional drive into the RAID set and then expand the volumes on the fly. This happens transparently while the volumes are online, but, at the end of the process, the operating system will detect free space at after the existing volume.

Windows, NetWare and other advanced operating systems support volume expansion, which enables you to incorporate the additional free space within the volume into the operating system partition. The operating system partition is extended to incorporate the free space so it can be used by the operating system without creating a new operating system partition.

You can use the Diskpart.exe command line utility, included with Windows Server 2003 or the Windows 2000 Resource Kit, to extend an existing partition into free space in the dynamic disk.

Third-party software vendors have created utilities that can be used to repartition disks without data loss. Most of these utilities work offline. Partition Magic is one such utility.

High availability

• Global Hot Spares

A global hot spare is an unused online available drive, which is ready for replacing the failure disk. The global hot spare is one of the most important features that SATA RAID controllers provide to deliver a high degree of fault-tolerance. A global hot spare is a spare physical drive that has been marked as a global hot spare and therefore is not a member of any RAID set. If a disk drive used in a volume set fails, then the global hot spare will automat-

ically take its place and the data previously located on the failed drive is reconstructed on the global hot spare.

For this feature to work properly, the global hot spare must have at least the same capacity as the drive it replaces. Global hot spares only work with RAID level 1, 10, 3, 5, or 6 volume set. You can configure up to three global hot spares with ARC-11xx/12xx.

The "Create Hot Spare" option gives you the ability to define a global hot spare disk drive. To effectively use the global hot spare feature, you must always maintain at least one drive that is marked as a global spare.

Important:

The hot spare must have at least the same capacity as the drive it replaces.

• **Hot-Swap Disk Drive Support**

The SATA controller chip includes a protection circuit that supports the replacement of SATA hard disk drives without having to shut down or reboot the system. A removable hard drive tray can deliver "hot swappable" fault-tolerant RAID solutions at prices much less than the cost of conventional SCSI hard disk RAID controllers. This feature provides advanced fault tolerant RAID protection and "online" drive replacement.

• **Auto Declare Hot-Spare**

If a disk drive is brought online into a system operating in degraded mode, The SATA RAID controllers will automatically declare the new disk as a spare and begin rebuilding the degraded volume. The auto declare hot-spare function requires that the smallest drive contained within the volume set in which the failure occurred.

In the normal status, the newly installed drive will be reconfigured an online free disk. But, the newly-installed drive is automatically assigned as a hot spare if any hot spare disk was used to rebuild and without new installed drive replaced it. In this condition, the auto declare hot-spare status will be disappeared if the RAID subsystem has since powered off/on.

APPENDIX

The Hot-Swap function can be used to rebuild disk drives in arrays with data redundancy such as RAID level 1, 10, 3, 5, and 6.

• Auto Rebuilding

If a hot spare is available, the rebuild starts automatically when a drive fails. The SATA RAID controllers automatically and transparently rebuild failed drives in the background at user-definable rebuild rates.

If a hot spare is not available, the failed disk drive must be replaced with a new disk drive so that the data on the failed drive can be automatically rebuilt and so that fault tolerance can be maintained.

The SATA RAID controllers will automatically restart the system and the rebuilding process if the system is shut down or powered off abnormally during a reconstruction procedure condition.

When a disk is hot swapped, although the system is functionally operational, the system may no longer be fault tolerant. Fault tolerance will be lost until the removed drive is replaced and the rebuild operation is completed.

During the automatic rebuild process, system activity will continue as normal, however, the system performance and fault tolerance will be affected.

• Adjustable Rebuild Priority

Rebuilding a degraded volume incurs a load on the RAID subsystem. The SATA RAID controllers allow the user to select the rebuild priority to balance volume access and rebuild tasks appropriately. The "Background Task Priority" is a relative indication of how much time the controller devotes to a background operation, such as rebuilding or migrating.

The SAS RAID controller allows user to choose the task priority (Ultra Low (5%), Low (20%), Medium (50%), High (80%)) to balance volume set access and background tasks appropriately. For high array performance, specify an "Ultra Low" value. Like volume

initialization, after a volume rebuilds, it does not require a system reboot.

High Reliability

• Hard Drive Failure Prediction

In an effort to help users avoid data loss, disk manufacturers are now incorporating logic into their drives that acts as an "early warning system" for pending drive problems. This system is called SMART. The disk integrated controller works with multiple sensors to monitor various aspects of the drive's performance, determines from this information if the drive is behaving normally or not, and makes available status information to RAID controller firmware that probes the drive and look at it.

The SMART can often predict a problem before failure occurs. The controllers will recognize a SMART error code and notify the administrator of an impending hard drive failure.

• Auto Reassign Sector

Under normal operation, even initially defect-free drive media can develop defects. This is a common phenomenon. The bit density and rotational speed of disks is increasing every year, and so are the potential of problems. Usually a drive can internally remap bad sectors without external help using cyclic redundancy check (CRC) checksums stored at the end of each sector.

SATA drives perform automatic defect re-assignment for both read and write errors. Writes are always completed - if a location to be written is found to be defective, the drive will automatically relocate that write command to a new location and map out the defective location. If there is a recoverable read error, the correct data will be transferred to the host and that location will be tested by the drive to be certain the location is not defective. If it is found to have a defect, data will be automatically relocated, and the defective location is mapped out to prevent future write attempts.

In the event of an unrecoverable read error, the error will be reported to the host and the location will be flagged as being po-

APPENDIX

tentially defective. A subsequent write to that location will initiate a sector test and relocation should that location prove to have a defect. Auto Reassign Sector does not affect disk subsystem performance because it runs as a background task. Auto Reassign Sector discontinues when the operating system makes a request.

• Consistency Check

A consistency check is a process that verifies the integrity of redundant data. To verify RAID 3, 5 or 6 redundancy, a consistency check reads all associated data blocks, computes parity, reads parity, and verifies that the computed parity matches the read parity.

Consistency checks are very important because they detect and correct parity errors or bad disk blocks in the drive. A consistency check forces every block on a volume to be read, and any bad blocks are marked; those blocks are not used again. This is critical and important because a bad disk block can prevent a disk rebuild from completing. We strongly recommend that you run consistency checks on a regular basis—at least once per week. Note that consistency checks degrade performance, so you should run them when the system load can tolerate it.

Data Protection

• Battery Backup

The SATA RAID controllers are armed with a Battery Backup Module (BBM). While a Uninterruptible Power Supply (UPS) protects most servers from power fluctuations or failures, a BBM provides an additional level of protection. In the event of a power failure, a BBM supplies power to retain data in the RAID controller's cache, thereby permitting any potentially dirty data in the cache to be flushed out to secondary storage when power is restored.

The batteries in the BBM are recharged continuously through a trickle-charging process whenever the system power is on. The batteries protect data in a failed server for up to three or four days, depending on the size of the memory module. Under nor-

mal operating conditions, the batteries last for three years before replacement is necessary.

- **Recovery ROM**

The SATA RAID controller firmware is stored on the flash ROM and is executed by the I/O processor. The firmware can also be updated through the PCI-X/PCIe bus port or Ethernet port (if equipped) without the need to replace any hardware chips. During the controller firmware upgrade flash process, it is possible for a problem to occur resulting in corruption of the controller firmware. With our Redundant Flash Image feature, the controller will revert back to the last known version of firmware and continue operating. This reduces the risk of system failure due to firmware crash.

Appendix F

Understanding RAID

RAID is an acronym for Redundant Array of Independent Disks. It is an array of multiple independent hard disk drives that provides high performance and fault tolerance. The SATA RAID controller implements several levels of the Berkeley RAID technology. An appropriate RAID level is selected when the volume sets are defined or created. This decision should be based on the desired disk capacity, data availability (fault tolerance or redundancy), and disk performance. The following section discusses the RAID levels supported by the SATA RAID controller.

The SATA RAID controller makes the RAID implementation and the disks' physical configuration transparent to the host operating system. This means that the host operating system drivers and software utilities are not affected, regardless of the RAID level selected. Correct installation of the disk array and the controller requires a proper understanding of RAID technology and the concepts.

APPENDIX

• RAID 0

RAID 0, also referred to as striping, writes stripes of data across multiple disk drives instead of just one disk drive. RAID 0 does not provide any data redundancy, but does offer the best high-speed data throughput. RAID 0 breaks up data into smaller blocks and then writes a block to each drive in the array. Disk striping enhances performance because multiple drives are accessed simultaneously; the reliability of RAID level 0 is less because the entire array will fail if any one disk drive fails.

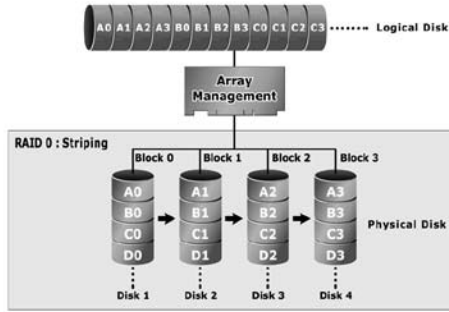

• RAID 1

RAID 1 is also known as “disk mirroring”; data written on one disk drive is simultaneously written to another disk drive. Read performance will be enhanced if the array controller can, in parallel, access both members of a mirrored pair. During writes, there will be a minor performance penalty when compared to writing to a single disk. If one drive fails, all data (and software applications) are preserved on the other drive. RAID 1 offers extremely high data reliability, but at the cost of doubling the required data storage capacity.

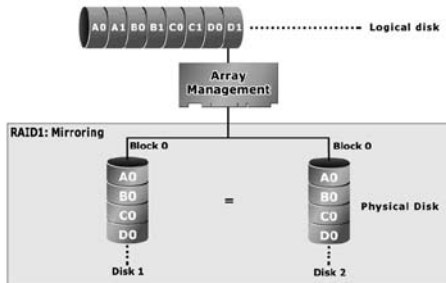

• RAID 10(1E)

RAID 10(1E) is a combination of RAID 0 and RAID 1, combining striping with disk mirroring. RAID Level 10 combines the fast performance of Level 0 with the data redundancy of Level 1. In this configuration, data is distributed across several disk drives, similar to Level 0, which are then duplicated to another set of drive for data protection. RAID 10 has been traditionally implemented using an even number of disks, some hybrids can use an odd number of disks as well. Illustration is an example of a hybrid RAID 10(1E) array comprised of five disks; A, B, C, D and E. In this configuration, each strip is mirrored on an adjacent disk with wrap-around. Areca RAID 10 offers a little more flexibility in choosing the number of disks that can be used to constitute an array. The number can be even or odd.

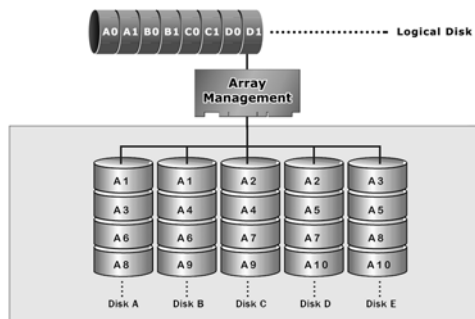

• RAID 3

RAID 3 provides disk striping and complete data redundancy through a dedicated parity drive. RAID 3 breaks up data into smaller blocks, calculates parity by performing an exclusive-or on the blocks, and then writes the blocks to all but one drive in the array. The parity data created during the exclusive-or is then written to the last drive in the array. If a single drive fails, data is still available by computing the exclusive-or of the contents corresponding strips of the surviving member disk. RAID 3 is best for applications that require very fast data-transfer rates or long data blocks.

APPENDIX

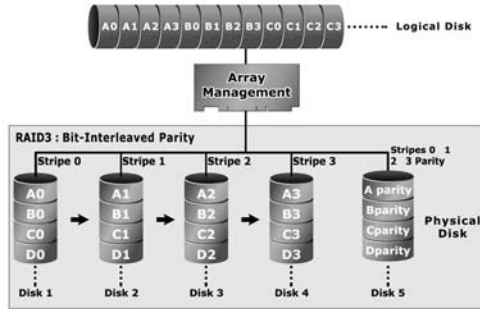

• RAID 5

RAID 5 is sometimes called striping with parity at byte level. In RAID 5, the parity information is written to all of the drives in the controllers rather than being concentrated on a dedicated parity disk. If one drive in the system fails, the parity information can be used to reconstruct the data from that drive. All drives in the array system can be used for seek operations at the same time, greatly increasing the performance of the RAID system. This relieves the write bottleneck that characterizes RAID 4, and is the primary reason that RAID 5 is more often implemented in RAID arrays.

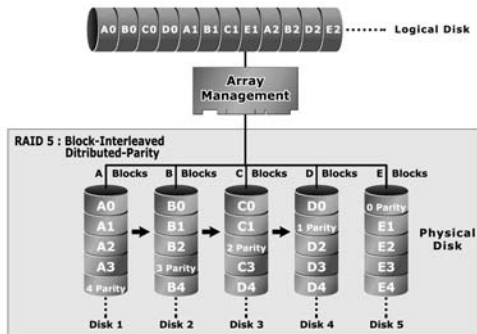

• RAID 6

RAID 6 provides the highest reliability. It is similar to RAID 5, but it performs two different parity computations or the same computation on overlapping subsets of the data. RAID 6 can offer fault tolerance greater than RAID 1 or RAID 5 but only consumes the capacity of 2 disk drives for distributed parity data. RAID 6 is an extension of RAID 5 but uses a second, independent distributed parity scheme. Data is striped on a block level across a set of drives, and then a second set of parity is calculated and written across all of the drives.

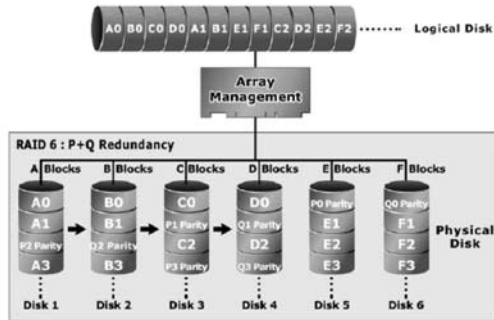

Summary of RAID Levels

The SATA RAID controller supports RAID Level 0, 1, 10(1E), 3, 5 and 6. The table below provides a summary of RAID levels.

Features and Performance					
RAID Level	Description	Min. Drives	Data Reliability	Data Transfer Rate	I/O Request Rates
0	Also known as striping Data distributed across multiple drives in the array. There is no data protection.	1	No data Protection	Very High	Very High for Both Reads and Writes

APPENDIX

1	Also known as mirroring All data replicated on N separated disks. N is almost always 2. This is a high availability solution, but due to the 100% duplication, it is also a costly solution. Half of drive capacity in array devoted to mirroring.	2	Lower than RAID 6; Higher than RAID 3, 5	Writes similar to a single disk	Reads are twice as fast as a single disk; Writes are similar to a single disk.
10(1E)	Also known Block-Interleaved Parity. Data and parity information is subdivided and distributed across all disks. Parity must be the equal to the smallest disk capacity in the array. Parity information normally stored on a dedicated parity disk.	3	Lower than RAID 6; Higher than RAID 3, 5	Transfer rates more similar to RAID 1 than RAID 0	Reads are twice as fast as a single disk; Writes are similar to a single disk.
3	Also known Bit-Interleaved Parity. Data and parity information is subdivided and distributed across all disks. Parity data consumes the capacity of 1 disk drive. Parity information normally stored on a dedicated parity disk.	3	Lower than RAID 1, 10, 6; Higher than a single drive	Reads are similar to RAID 0; Writes are slower than a single disk	Reads are close to being twice as fast as a single disk; Writes are similar to a single disk.
5	Also known Block-Interleaved Distributed Parity. Data and parity information is subdivided and distributed across all disk. Parity data consumes the capacity of 2 disk drive.	3	Lower than RAID 1, 10, 6; Higher than a single drive	Reads are similar to RAID 0; Writes are slower than a single disk	Reads are similar to RAID 0; Writes are slower than a single disk.

APPENDIX

6	RAID 6 provides the highest reliability. Similar to RAID 5, but does two different parity computations. RAID 6 offers fault tolerance greater than RAID 1 or RAID 5. Parity data consumes the capacity of 2 disk drives.	4	Highest reliability	Reads are similar to RAID 0; Writes are slower than a single disk	Reads are similar to RAID 0; Writes are slower than a single disk.
---	--	---	---------------------	--	---

APPENDIX

Appendix G

Technical Support

Areca Technical Support provides several options for Areca users to access information and updates. We encourage you to use one of our electric services, for the latest product information updates and efficient support service. If you have decided to contact us, please have the following information ready. Kindly provide us the product model, serial number, BIOS, driver version, and a detailed description of the problem at **http://www.areca.com.tw/support/ask_a_question.htm** Our support team will be glad to answer all your technical enquires.

Version History

Revision	Page	Description
4.01	p.52, 66	For Windows changed to Use 4K Block
4.01	p.58, 121	Added a note for RAID set expand
4.01	p.84, 87	Added HDD Power Management and LED Polarity Setting
4.01	p.135	Added HDD Power Management